

Complete Streets Considerations for Freight and Emergency Vehicle Operations



Complete Streets Considerations for Freight and Emergency Vehicle Operations

Prepared for:

New York State Energy Research and Development Authority
Albany, New York

Robyn Marquis

Project Manager – Clean Transportation

Prepared by:

The City College of New York

New York, NY

Alison Conway, Associate Professor of Civil Engineering

June Williamson, Associate Professor of Architecture

Research Assistants:

Marija Gjorgjievska

Quanquan Chen

Linette Prasad

Crystal Xing

New York City Department of Transportation

Office of Freight Mobility

New York, NY

Diniece Peters, Director (2018)

Stacey Hodge, Director (2016-2017)

Nichola Mammes, Project Manager

Michael Klatsky, Project Manager



Notice

This report was prepared by the City College of New York and New York City Department of Transportation in the course of performing work contracted for and sponsored by the New York State Energy Research and Development Authority (hereafter “NYSERDA”). The opinions expressed in this report do not necessarily reflect those of NYSERDA or the State of New York, and reference to any specific product, service, process, or method does not constitute an implied or expressed recommendation or endorsement of it. Further, NYSERDA, the State of New York, and the contractor make no warranties or representations, expressed or implied, as to the fitness for particular purpose or merchantability of any product, apparatus, or service, or the usefulness, completeness, or accuracy of any processes, methods, or other information contained, described, disclosed, or referred to in this report. NYSERDA, the State of New York, and the contractor make no representation that the use of any product, apparatus, process, method, or other information will not infringe privately owned rights and will assume no liability for any loss, injury, or damage resulting from, or occurring in connection with, the use of information contained, described, disclosed, or referred to in this report.

NYSERDA makes every effort to provide accurate information about copyright owners and related matters in the reports we publish. Contractors are responsible for determining and satisfying copyright or other use restrictions regarding the content of reports that they write, in compliance with NYSERDA’s policies and federal law. If you are the copyright owner and believe a NYSERDA report has not properly attributed your work to you or has used it without permission, please email print@nysesda.ny.gov

Information contained in this document, such as web page addresses, are current at the time of publication.

Contents

Acronyms

Introduction

1 Fundamentals of Freight

- 1.1 Freight Demand
- 1.2 Freight Stakeholders
- 1.3 Freight Vehicles
- 1.4 Parking and Loading Infrastructure
- 1.5 Freight Regulations
- 1.6 Common CV Challenges in Complete Streets Areas

2 Fundamentals of Emergency Services

- 2.1 Demand for Emergency Services
- 2.2 Emergency Service Providers
- 2.3 Emergency Service Vehicles
- 2.4 Emergency Response Infrastructure
- 2.5 Emergency Service Regulations
- 2.6 Common Emergency Operator Challenges in Complete Streets Areas

3 Street Design and Management

Considerations

- 3.1 Selecting an Appropriate Design and Control Vehicle
 - 3.1.1 Critical Vehicle Dimensions
 - 3.1.2 Design Vehicle vs. Control Vehicle
 - 3.1.3 Existing Recommendations
 - 3.1.4 Selection Criteria
- 3.2 Providing Adequate Space for Large Vehicle Turns
 - 3.2.1 Curbside Parking Lanes

- 3.2.2 Curbside Bicycle Lanes
- 3.2.3 Asymmetrical Median Nose
- 3.2.4 Recessed Stop Line
- 3.2.5 Mountable or Flush Curbs
- 3.2.6 Painted, Striped, or Textured Curb Extensions
- 3.2.7 Channelized Right Turn Lanes
- 3.2.8 Vehicle Size Restrictions
- 3.2.9 Dedicated Signal Phases for Turning Movements
- 3.3 Reducing the Frequency and Severity of Conflicts Between Large Vehicles and Vulnerable Roadway Users
 - 3.3.1 Bike Boxes and Two-Phase Turn Queue Boxes
 - 3.3.2 Paint and Pavement Texturing to Delineate Conflict Areas
 - 3.3.3 Dedicated or Leading Signal Phases for Non-motorized Travelers
 - 3.3.4 Convex Safety Mirrors
 - 3.3.5 On-Board Blind Spot Mitigation
 - 3.3.6 Truck Side Guards
 - 3.3.7 Education Programs
- 3.4 Reducing Speeds Without Unintended Detrimental Impacts on Operations and Safety
 - 3.4.1 Speed Cushions
 - 3.4.2 Mini Roundabouts
- 3.5 Providing Network Connectivity and Redundancy
 - 3.5.1 Redundant Networks
 - 3.5.2 Wide Bike Lanes
 - 3.5.3 Mountable Medians

- 3.6 Providing Adequate Space for Vehicle Parking and Loading, and Delivery or Emergency Operations
 - 3.6.1 Dedicated On-street Loading Zones
 - 3.6.2 Offset Bus and Bicycle Lanes
 - 3.6.3 Mountable Sidewalk or Sidewalk Cutouts
 - 3.6.4 Zoning Regulations
 - 3.6.5 Building Delivery Management
 - 3.6.6 Commercial Meter Pricing
 - 3.6.7 Flexible Curb Regulations
 - 3.6.8 Enforcement
- 3.7 Providing Safe Access to Sidewalks, Buildings, and Fire Hydrants
 - 3.7.1 Mid-block Curb Cuts
 - 3.7.2 Vertical Clearance Zone
 - 3.7.3 Horizontal Clearance Zone
 - 3.7.4 Shared Streets

4 Demand Management Strategies

- 4.1 Off-hour Deliveries
- 4.3 Lockers and Pick-up Points
- 4.2 Urban Consolidation Centers
- 4.4 Secondary Referral Services
- 4.5 Building Sprinklers

5 Additional Resources

6 Credits

Acknowledgments

The authors would like to thank the following individuals/organizations who assisted in development of this guidebook. Inclusion on this list does not indicate endorsement of the final guidebook content.

For participating in a survey of US city experience:

Christopher Eaves, Seattle Department of Transportation
Charlotte Fleetwood, Boston Transportation Department
Dan Gallagher, Charlotte Department of Transportation
Akshali Gandhi, City of Pittsburgh City Planning
Lawrence Hall, Northeast Ohio Areawide Coordinating Agency (NOACA)
Bob Hillier, City of Portland, Bureau of Transportation
Mike Kubek, Northeast Ohio Areawide Coordinating Agency (NOACA)
Mauricio Leclerc, Portland Bureau of Transportation
Susan McLaughlin, City of Seattle
Jeff O'Brien, Louisville Metro Government
Diniece Peters, New York City Department of Transportation
Laura Richards, District Department of Transportation
Mike Schofield, City of Austin Transportation Department
Melissa Thompson, Northeast Ohio Areawide Coordinating Agency (NOACA)

For assisting with distribution of the survey of US experience:

Ted Dahlburg, Delaware Valley Regional Planning Commission
Stephanie Dock, District Department of Transportation
Jennifer Duthie, City of Austin
Barb Ivanov, University of Washington
Craig Toocheck, National Association of City Transportation Officials
Avinash Unnikrishnan, Portland State University

For providing information on international practices:

Laetitia Dablanc, IFSTTAR, Paris, France
Toril Presttun, Statens vegvesen, Oslo, Norway

For providing guidance and base files for visualization development:

Tim Love, Utile
Meera Deena, Utile

For hosting presentations of preliminary content for expert feedback:

Urban Freight Platform, Gothenburg, Sweden
Delaware Valley Regional Planning Commission, Philadelphia, PA
Lehigh Valley Planning Commission, Allentown, PA

For supporting initial research that inspired guidebook development:

Volvo Research and Education Foundations through the MetroFreight Center

Acronyms

AASHTO	American Association of State Highway and Transportation Officials
ALS	Advanced Life Support
BLS	Basic Life Support
DOT	Department of Transportation
EMS	Emergency Medical Services
EMT	Emergency Medical Technician
FDNY	City of New York Fire Department
FHWA	Federal Highway Administration
GVW	Gross Vehicle Weight
NACTO	National Association of City Transportation Officials
NFPA	National Fire Protection Association
NCHRP	National Cooperative Highway Research Program
NCFRP	National Cooperative Freight Research Program
NYC	New York City
NYPD	City of New York Police Department
OOIDA	Owner Operator Independent Drivers Association
UCC	Urban Consolidation Center
VMT	Vehicle Miles Traveled

Introduction

According to the National Complete Streets Coalition,

A Complete Streets approach integrates people and place in the planning, design, construction, operation, and maintenance of our transportation networks. This helps to ensure streets are safe for people of all ages and abilities, balance the needs of different modes, and support local land uses, economies, cultures, and natural environments.¹

Two groups of street users critical to support community needs are freight carriers and emergency service providers. Freight carriers give neighborhood residents access to the material goods essential to support their quality of life and enable the economic vitality of local businesses that both employ and serve community residents. They also remove unwanted materials such as household and commercial waste and construction and demolition byproducts that pose a threat to public health, the environment, and neighborhood habitability. Emergency service providers protect the health, safety, and prosperity of local residents and employees by responding rapidly and reliably to incidents that threaten lives and destroy property.

Yet, despite the importance of their functions during multimodal street planning and design, these operators are often overlooked or viewed as a nuisance due to the safety and environmental challenges their unique operations pose on compact facilities. Many freight vehicles are larger and heavier than passenger vehicles; as a result, they require more space for navigation and parking, produce greater impacts on traffic congestion and infrastructure, and are major generators of air pollutants, greenhouse gases, and noise. Some emergency vehicles—particularly aerial fire apparatus—are also longer and heavier than typical vehicles in the neighborhoods they serve. Perhaps most concerning when designing a street for the safety of all users, both large and fast moving vehicles present a dangerous collision risk for other travelers, especially pedestrians and cyclists. The externalities and risks that freight and emergency vehicles pose in communities are real and concerning; unfortunately, these impacts cannot be decoupled from the tremendous demand for emergency services and consumer goods deliveries generated by the same communities.

Highly populated or business dense areas generate significant demand for everyday goods. In an economically diverse community, necessary

freight movements to fulfill this demand will include large-scale truck trips to and from major manufacturing and warehousing facilities, as well as medium- and small-scale deliveries to local businesses and residents. Deliveries and pickups will not be concentrated at a few isolated locations or only during certain hours of the day, but rather will be fulfilled at times and locations dictated by local receivers and shippers. Even in residential areas, individual shoppers can now specify both the time and speed of delivery directly to their homes for any number of household and consumer goods. These on-demand

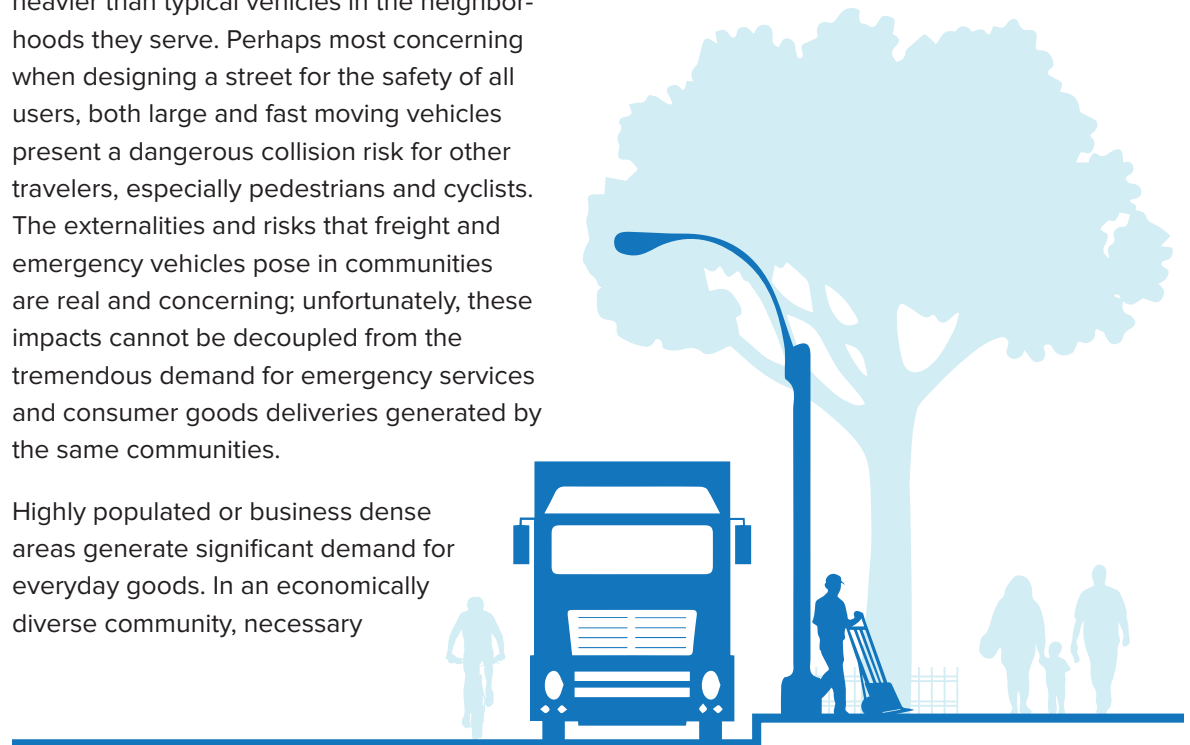

deliveries generate home delivery trips and may also require complex networks of distribution facilities, some of which will need to be located in or close to the communities that they serve. While demand management strategies such as off-hour deliveries, lockers and pick-up points, and urban consolidation centers can be implemented to reduce some last-mile freight activity and associated externalities, these solutions will not be feasible for all stakeholders or sectors.

Emergency responders must also meet local needs for services. Personal medical emergencies, traffic collisions, crimes, and natural and man-made disasters occur where people live, work, and travel. Fire stations, police stations, and hospitals are located in or close to the communities they serve. While large police and fire departments may have diverse fleets of specialized vehicles to respond to different incidents, in smaller communities, a few large vehicles may need to carry a wide variety of equipment for response to different emergencies. In densely developed areas, rapid fire response is needed to reduce spread to adjacent and nearby buildings; if buildings are tall, firefighters will need aerial equipment to reach high floors. Programs such as secondary medical referral service can help reduce demand for ambulance trips, and effective building design—including the installation of sprinklers—can help to reduce the demand for high-speed fire response; however, these alternatives will not eliminate all life-threatening

medical and fire emergencies.

Recognizing that there is a need for goods movements and emergency service operations in livable communities, and that these activities will need to occur in neighborhoods, on streets, and at curbsides shared with pedestrians, cyclists, passenger vehicles, and transit, the aim of this guide is to:

- ◆ **Provide a comprehensive introduction to freight and emergency vehicle operations in livable communities.**
- ◆ **Outline the common challenges that freight and emergency vehicle operators face on compact, mixed-use streets.**
- ◆ **Identify design, regulatory, and operational strategies to address these common challenges.**
- ◆ **Briefly introduce feasible demand management strategies that can be implemented to reduce some freight and emergency trips.**

Endnotes

¹ National Complete Streets Coalition.

1 Fundamentals of Freight

By its most basic definition, freight transportation is the movement of goods from one place to another. In a livable community, freight is the shipments to, from, and between the local businesses and residents who depend on the safe and timely movement of these goods to support their everyday activities. In recent decades, with the emergence of global markets, just-in-time manufacturing and retailing, ecommerce, and on-demand delivery services, businesses and residents have become increasingly dependent on complex supply chains to quickly deliver goods originating locally, regionally, nationally, or internationally, often within narrowly defined timeframes. While a full description of supply chain organization is beyond the scope of this guidebook, readers are referred to *NCHRP Report 14: Guidebook for Understanding Urban Goods Movements*¹ for a detailed discussion. Failure of supply chains to meet local demands can result in lack of access to necessary or desired products for residents and in increased operating costs and in decreased service quality for local businesses that depend on the delivery of products to conduct their business activities. High transportation costs ultimately raise the cost of goods for end consumers and can also reduce local economic competitiveness if businesses choose to locate in alternative areas with better goods accessibility.

Planning for freight access in a livable community first requires an understanding of the fundamental drivers of freight demand and



Residential delivery van

a basic understanding of the variables that influence freight activity. The following sections provide a brief introduction to the generators of freight demand; the stakeholders who play a role in generating and fulfilling this demand; the vehicles used to complete goods movements; the infrastructure needed to support these movements; the local regulations that may influence freight activity; and finally, the common challenges that freight vehicles often face when operating on multimodal streets.

1.1 Freight Demand

In a livable community, a number of different types of activities will generate demand for goods movements. This section briefly describes common generators of freight transportation activity. For a more detailed discussion of the number and characteristics of freight trips gener-

ated by different land uses, readers are referred to *NCHRP Report 739/NCFRP Report 19: Freight Trip Generation and Land Use*.²

Retail Stores

Retail stores rely on timely delivery of goods for sale to their customers. The time, size, and frequency of incoming freight trips will vary depending on the size of the store, the operating hours of the store, the type of goods sold, whether arriving goods are from a single distribution center or from multiple distributors, and whether the store holds extra stock on sight or relies on on-demand replenishment. Retail stores may also ship goods to in-store or online customers. Failed incoming or outgoing deliveries can result in lost sales and lost customers.

Restaurants

Restaurants rely on timely delivery of fresh products to prepare meals for sale to their customers. Perishable products may require careful temperature control during handling and storage. Deliveries to restaurants are often scheduled during hours when staff will be on site to accept deliveries, but when customer demand is low. For perishable products, deliveries may be timed to maximize the quality of the product at the expected time of sale. Restaurants may also ship meals on-demand to in-store or online customers. Failed incoming or outgoing deliveries can result in lost sales and lost customers.

Offices

Business offices serving a variety of sectors have a broad road range of needs for material goods. Offices may receive goods such as office supplies, food and beverages, documents, and tools of the trade practiced (e.g., medical supplies in a medical office). Failed deliveries of necessary supplies or time sensitive documents could result in poor service and lost customers.

Homes

Over the last decade, consumer shopping behavior has rapidly shifted. Individuals are becoming increasingly reliant on direct-to-home-deliveries of everyday products such as groceries, pharmaceuticals, clothing, and other household goods. While exact demands will vary considerably as a function of both the built environment and shopper demographics,³ a 2016 study of a 300-unit apartment building in Fort Lee, NJ estimated that each apartment unit generated about 1.5 deliveries per week.⁴ Online shoppers often have options to control the speed and delivery time of shipments, resulting in deliveries at all times of day. Failed deliveries can result in unsatisfied customers and expensive repeated trips for a carrier.

Manufacturers

Manufacturers rely on timely delivery of the raw or component materials that are inputs to their production processes. Delivery delays can halt production, resulting in expensive delays and ultimately a shortage of goods for sale. Man-



Accumulated waste

ufacturers also ship finished products to their customers. Failed outgoing deliveries can result in lost sales and customers.

Construction

Construction sites rely on timely arrival and removal of materials, including heavy products such as wood, steel, and concrete. Delays in material arrival or pickup can halt work, resulting in expensive construction delays. Some materials, such as wet concrete, may themselves be time sensitive.

Waste Removal

Both businesses and residences generate waste. In most communities, waste is picked up via truck by public sanitation departments or by private haulers. Waste can be picked up from the curbside or from dumpsters located off-street. Failed waste pickup can result in accumulated waste in a community, which can cause



Unloading at the sidewalk

detrimental environmental and public health impacts.

Other Local Activities

In addition to the categories previously listed, innumerable types of material movements may occur to meet the needs of a local economy and population; a few very specific examples from New York City include the movement of the sets, props, equipment, and supplies demanded for television, movie, and theater productions; transportation of pharmaceuticals, equipment, and other support supplies to regional hospitals; distribution of office, classroom, and laboratory supplies to local universities and schools; and the redistribution of bicycles and station infrastructure to support the local bikeshare network.

1.2 Freight Stakeholders

Goods movements are distinct from passenger movements in that they often involve multiple decision-makers. For the purpose of planning, designing, and operating local streets, it is important to recognize the role of different actors in the first-mile and last-mile goods movements that will occur in a local area. First-mile transportation is the initial movement of goods away from a shipper's location. Last-mile transportation is the final movement of goods to a receiver. Three key actors influence when and how these goods movements occur.⁵

Receiver

A receiver is an end cargo owner to whom goods are being delivered. Receivers may be local businesses or individual residents. Receivers determine what goods must be delivered, how frequently deliveries must occur, and often, at what speed and during what specific timeframe deliveries must be made. The goal of a receiver is to have safe and on-time delivery of products ordered, usually for minimum cost.

Shipper

A shipper is an original cargo owner from whom goods are shipped. Shippers fill orders placed by receivers. Local shippers may generate goods movements outgoing to local or distant receivers. Goods movements incoming to a local area may originate from local or distant shippers.

The goal of a shipper is to ensure receiver satisfaction with a product and delivery.

Carrier

A carrier is a logistics provider who moves goods from one place to another.⁶ A carrier must meet the delivery needs of the receiver. A carrier may operate locally, regionally, nationally, or internationally. A carrier may complete a direct point-to-point movement for a single customer, or may serve multiple customers on a delivery tour. Carriers will determine the vehicles, staff, and equipment required to complete goods movements, the routes traveled, and the organization of delivery tours. The priority of the carrier is to meet the needs of the receiver while also minimizing the cost of a delivery.

Infrastructure Managers

While freight vehicles operate primarily on public right-of-way, deliveries can occur in public space (on-street) or in private space (off-street) (see section 1.3). As a result, both private and public infrastructure managers can influence the efficiency of freight operations and delivery activity in a local area. The responsibilities of individual actors will vary by state and municipality; however, key stakeholders typically include:

- ◆ City planning agencies, that establish zoning codes defining on- and off-street parking and loading requirements for different land uses.

- ◆ State departments of transportation that manage interstate highways and other national network facilities where freight vehicles operate.
- ◆ Local (or state) departments of transportation, that operate and regulate local street and curb space.
- ◆ Parking authorities, finance offices, or other city or state entities that establish local permit requirements/rates and parking violation fees.
- ◆ Police departments or other enforcement authorities who issue tickets and perform related enforcement functions.
- ◆ Building managers who allocate space for delivery and storage and establish on-site or in-building regulations for delivery activities and loading dock operations.
- ◆ Private developers who determine off-street space allocated for loading/unloading activities in new developments.

Stakeholder Engagement

Engaging these freight stakeholders in a local project planning process can be a challenge. Some freight stakeholders, such as shippers and carriers, may be based in a location outside of a local jurisdiction. As a result, they may be unlikely to participate in typical local outreach activities such as public meetings. A variety of strategies can be implemented to engage



Freight vehicles parked along a single block

freight stakeholders early in a project planning process. These include:

- ◆ Consultation with internal agency freight experts, where applicable; for example, in NYC, the DOT has an Office of Freight Mobility and in Portland, the Bureau of Transportation has a full time Freight Coordinator.
- ◆ Consultation with agency advisory boards, where applicable; for example, the Portland Freight Committee meets monthly to advise the city on freight-related issues.⁷
- ◆ Consultation with a local freight quality partnership, where applicable; for example, in London, ongoing partnerships between local industry operators and local authorities have been established to jointly address freight access needs and community impacts from freight operations.⁸
- ◆ Consultation with freight industry associations such as a State trucking association or the Owner Operator Independent Driver Association (OOIDA).
- ◆ Consultation with or participation in a meeting of a business improvement district or similar association of local business owners.
- ◆ Field visits to local businesses.
- ◆ On-site, online, or telephone surveying of businesses, building managers, or carriers operating in a project area.

For detailed discussion of stakeholder outreach efforts by states and MPOs throughout the U.S., readers are referred to FHWA's *A Guidebook for Engaging the Private Sector in Freight Transportation Planning*.⁹

1.3 Freight Vehicles

Goods movements can occur by a variety of vehicle types depending on the type of goods moved, the types of customers served, the organization of the supply chain, and local regulations (see section 1.4). While goods may move into a region via another transportation mode such as rail or water, nearly all first-mile and last-mile movements will be completed by a truck, van, car, or non-motorized vehicle. The most common motorized vehicle for long-distance movements in the U.S. is a five axle semitrailer truck, which typically consists of a tractor and a 48- or 53-foot semitrailer. Even in densely developed areas, goods movements to or from large manufacturing facilities and warehouses, and deliveries to major retailers such as grocery or department stores are commonly made by five axle semitrailers. For intermodal movements, shorter trucks consisting of a tractor and chassis carry standard 20- and 40-foot international shipping containers; these vehicles may be common in areas close to a port or intermodal yard. Examples of other common heavy-duty vehicles include construction vehicles, waste haulers/sanitation trucks, and fuel tankers. Deliveries to smaller scale retailers or manufacturers are more likely to be made by a single unit truck or even a cargo van rather than a large semitrailer. Parcel movements are commonly made by step van or cargo van, but may also be made by a single unit truck. In densely developed areas, local business-to-business (B2B)



48-foot semitrailer

or business-to-customer (B2C) deliveries are often made by car, bicycle, or even hand cart. In many U.S. and European cities, there has also been recent growth in the use of higher capacity cargo bicycles or tricycles for local movements; these can be used for local B2B or B2C deliveries, or for last-mile distribution of goods from a micro-consolidation center (see Chapter 4).



Clockwise from upper left: Heavy construction vehicle; Single-unit delivery truck; Step van; Sanitation truck

1.4 Parking and Loading Infrastructure

Freight loading and unloading activities can occur on-street or off-street. On-street, freight-carrying vehicles may park in parking spaces dedicated for commercial use, such as commercial loading zones or commercial metered zones. In many cities, spaces dedicated for commercial parking are used by both freight vehicle drivers and by service providers, such as utility companies, plumbers, electricians, etc. Freight vehicles may also park in space shared with passenger vehicles, such as metered, time-limited, or unregulated parking spaces.

Loading docks are common at large commercial and industrial buildings. Common loading dock types in urban areas include: enclosed loading docks, where the vehicle parks fully or partially within the building, and open, flush, or side loading docks, where the side or rear of a loading vehicle abuts a covered platform or a platform flush with a building wall.¹⁰ In many older buildings, loading docks may be undersized for modern trucks. In some cities, alleys provide an off-street location where drivers can park and directly access buildings or loading docks.



Clockwise from upper left: on-street loading zone; Enclosed loading dock; Alley
(Source: "Freight in Pioneer Square" (CC BY-NC 2.0) by Seattle Department of Transportation)

1.5 Freight Regulations

A number of types of local regulations can affect the types of freight vehicles operating, the routes on which they operate, and the locations where they park to conduct loading and unloading.

Truck Size and Weight Regulations

Truck size and weight regulations typically limit the weights, lengths, and/or heights of vehicles permitted to operate within a jurisdiction. In the United States, federal regulations define the maximum lengths, widths, and weights of vehicles permitted to operate on the national highway network.¹¹

- ◆ The maximum length of a combination truck may not exceed 65 or 75 feet, depending on the tractor-trailer connection type.
- ◆ No state may impose a trailer length limit of less than 48 feet on a semitrailer or less than 28 feet for combination trailers.
- ◆ No state may impose a vehicle width limit of more or less than 102 inches.
- ◆ On the Interstate highway system only, gross vehicle weight (GVW) cannot exceed 80,000 pounds; single axle weight cannot exceed 20,000 pounds, and tandem axle weight cannot exceed 34,000 pounds. For some vehicle configurations, lower GVW restrictions may apply as estimated using the federal bridge formula.

- ◆ In some states, grandfathered exceptions allow for operation of longer or heavier vehicles on the national network.

On non-interstate national network routes and routes that are state or locally controlled, authorities may set their own weight restrictions, which can exceed federal limits. For example, axle loads slightly higher than federally allowed loads are permitted in NYC on vehicles with pneumatic tires.¹² On routes that are state or locally controlled, the relevant governments can also establish their own length and height limits. Some states permit operation of 57 foot semi-trailers and of double- and triple-trailer trucks.¹³ While no federal height limit exists, state limits range from 13.5 to 14.5 feet.¹⁴

Particularly in urban areas where space is constrained, local limits are often more restrictive than State or federal limits. Local restrictions can apply to an entire network, to designated routes, or to specific areas. For example, in NYC, semi-trailer trucks longer than 55 feet and single-unit trucks longer than 35 feet are not permitted to operate within the boundaries of the city,¹⁵ except on a few designated routes that provide access for larger vehicles to reach JFK Airport and Long Island.¹⁶ State and local jurisdictions can also issue permits for operation of vehicles exceeding their size and weight limits.

Access Restrictions

In many areas, certain trucks may be restricted from operating on specific routes or in some or all areas of a city. For example, in NYC, all vehicles defined as a truck (six-tire, two-axle vehicles and vehicles with three or more axles) are required to travel on a designated network. Vehicles traveling through (not stopping in) any NYC borough must use “through truck routes,” which primarily include interstates and limited-access freeways. Vehicles traveling to or from locations in a borough are required to use “local truck routes,” which are primarily arterial roadways. Vehicles may only deviate from “local truck routes” to reach their final destination, and must take the most direct path available.

In Seattle, vehicles that are 30 or more feet long are not permitted to operate at all in a downtown traffic control zone during weekday morning and evening peak hours, are permitted only with permit during weekday mid-day hours and all day Saturday, and can operate without permit overnight and on Sundays.¹⁷ In many European cities, low emissions zones have been implemented that restrict the vehicles permitted to operate in defined areas of the city; limits are often based on vehicle size and emissions class, and may apply at all times or only during specific hours of the day.¹⁸ Noise regulations may also restrict freight operations at certain times of day.

Unintended Consequences of Size and Weight/Access Regulations

While local size and weight regulations can be effective to limit local heavy vehicle operations, they can be problematic for freight operators and can also produce unintended local impacts. Carriers very frequently serve markets that cross jurisdictional boundaries. Inconsistent size and weight regulations within a market served may require operators either to operate a separate fleet within a restricted area's boundaries or to operate vehicles smaller than the maximum allowed in surrounding areas; in either case, economies of scale can be lost, resulting in higher vehicle, labor, and/or fuel costs. When vehicle sizes are restricted, a single large vehicle trip may be replaced by two or more smaller vehicle trips, which will require additional drivers, and likely additional vehicle miles traveled to complete the same number of deliveries.¹⁹ Depending on the engine type of the vehicles, this additional mileage could require more fuel and generate more emissions. For trips originating outside of a restricted area, operators may need to transfer goods from a larger vehicle to a smaller vehicle, which requires an extra point of handling, with associated space and labor cost. Where possible, the resulting higher costs for this transportation will be passed on to receivers and ultimately to end consumers, who may be required to pay higher prices for their goods.

Similar challenges can result from access restrictions. When trucks are required to travel on a very restricted network, disruptions such as congestion or incidents can result in a significant increase in miles traveled when vehicles are diverted to the nearest alternative route, with associated increases in fuel consumption, emissions, and collision exposure. Trucks may also choose to illegally travel on routes not designated, or designed, for freight activity, which can result in infrastructure damage such as bridge hits and accelerated pavement deterioration. Noise regulations that limit overnight freight activity serve to concentrate activity during times of day when multi-modal demand for road and curb space is high, potentially resulting in safety conflicts, congestion impacts, and related emissions.

Imposing new local size and weight or access restrictions can also have structural impacts on the delivery industry. While large operators with regional or national fleets can simply reposition compliant vehicles from other markets to meet local requirements, small carriers and independent owner operators are more likely to bear a cost for vehicle replacement. As drivers are frequently already operating on small profit margins, introducing inefficiencies via regulation can simply drive these actors out of business.²⁰

Zoning Regulations

In many cities, local zoning ordinances establish off-street parking space and loading dock requirements, which can vary for different land uses and within different types of zoning districts. Typically, the number of parking spaces and loading docks required is determined as a function of building space, the number of building units, or other building characteristics. Zoning ordinances can also establish freight elevator requirements; specific buildings types above a certain size or height may be required to provide one or more separate elevators exclusively for goods movement. Freight elevators can reduce the duration of delivery events by eliminating excessive stopping and waiting off-vehicle. However, in many cities, the land uses covered and the number of off-street loading docks mandated by outdated regulations are inadequate to accommodate modern demand for goods movements, and freight elevator requirements are limited or nonexistent.²¹ For example, in NYC, where large residential towers may now generate thousands of weekly e-commerce deliveries, residential buildings are not required to dedicate space for off-street loading docks or freight elevators. As dedicating potentially valuable building space for these purposes reduces the space available for other revenue generating uses, developers are likely to be hesitant to do so without a mandate or incentive.

Parking Regulations

In dense areas where demand is high, on-street parking regulations are used to identify permitted uses of space, to prioritize use of parking space by system users, and to promote good parking behavior. As discussed in section 1.3, on-street parking spaces available for use by freight vehicles typically include shared spaces, which passenger or freight vehicles can use, and dedicated spaces, such as commercial loading zones, where only commercial vehicles are permitted to park. In many cities like NYC, some or all dedicated commercial spaces may be used by any vehicle with a commercial license plate, which typically includes both vehicles conducting goods movements as well as other types of service providers (e.g., utility companies). Service providers frequently occupy spaces for longer durations than freight carriers.²² In both shared and dedicated spaces, parking time limits or metering may be implemented to encourage vehicle turnover. In some locations, space may be dedicated for different uses based on the time of day; for example, a curbside lane on a major commercial street may be a travel lane during the morning peak hour, a dedicated commercial loading zone in the late morning, and metered parking for customers in the afternoon and evening.

Double parking

Effectiveness of Parking Regulations

In order for parking regulations to be effective—whether to control who is using a space or to limit the duration of a parking event—enforcement is required. In areas where enforcement is infrequent, where violation costs are relatively low, or where no reasonable parking option exists to conduct necessary goods movements, freight operators may choose to park in a convenient location rather than in a legal space. When delivery occurs on-street but parking space is not available at a delivery location, freight vehicles will frequently double park in a travel lane—which may or may not be legal depending on local regulations—or will

park in a convenient illegal location, such as at a bus stop or in front of a fire hydrant. When double parking or parking illegally, trucks are likely to select a location that provides convenient access to their delivery location; for example, near a block-end where a hand-cart can easily enter a raised curb. Similarly, where enforcement is lacking, passenger vehicles may obstruct loading activity by choosing to park in a space dedicated for commercial vehicles or in an area that restricts freight access, such as in an alley or in front of a loading dock.



1.5 Common Commercial Vehicle Challenges in Complete Streets Areas

When operating on shared, multi-modal streets, freight operators face a number of common challenges. Large truck operators frequently have difficulty navigating restricted turns, narrow lanes, and curved or circular travel paths. In areas where pedestrian and bicycles are likely to be operating in driver blind spots, there is high risk for dangerous collisions. Often, lane reduction and installation of dedicated infrastructure for pedestrians, bicyclists, and transit can result in reduced capacity, loss of redundancy, or changes in directionality on shared or even designated freight routes, often with limited alternative routes available. Allocation of dedicated space for other modes can also result in limited space for on-street parking and loading, and can also present new obstructions for off-street loading docks. Introduction of alternative curbside uses can also limit direct access

to buildings and curbsides, potentially resulting in dangerous loading and travel conditions for delivery personnel once they exit their vehicle. Street furniture, bicycle parking, trees, signage, bollards, and other curbside or sidewalk obstructions can also inhibit delivery activity if they obstruct vehicle parking, do not allow adequate space for loading activity, or inhibit the travel path of delivery personnel using typical loading equipment such as hand carts, dollies, or pallet jacks.

Chapter 3 discusses these challenges in detail, and provides design, operational, and regulatory approaches that can be implemented to address them.

Endnotes

- 1** Rhodes, S., Berndt, M., Bingham, P., Bryan, J., Cherrett, T., Plumeau, P., Weisbrod, R. (2012). *Guidebook for Understanding Urban Goods Movement*. NCFRP Report 14, Transportation Research Board of the National Academies of Sciences, Engineering, and Medicine, Washington, DC.
- 2** Holguín Veras, J., Jaller, M., Sánchez-Díaz, I., Wojtowicz, J., Campbell, S., Levinson, H., Lawson, C., Powers, E., and Tavasszy, L. (2012). *Freight Trip Generation and Land Use*. NCHRP Report 739/NCFRP Report 19, Transportation Research Board of the National Academies of Sciences, Engineering, and Medicine, Washington, DC.
- 3** Zhou, Y., and Wang, X. (2014). Explore the relationship between online shopping and shopping trips: An analysis with the 2009 NHTS data. *Transportation Research Part A: Policy and Practice*, Vol. 70. p. 1-9.
- 4** Rodrigue, J-P. (2017). Residential Parcel Deliveries: Evidence from a Large Apartment Complex. MetroFreight Center, Los Angeles, CA. Accessed from: https://www.metrans.org/sites/default/files/MF_5.1a_Residential_Parcel_Deliveries_Final_Report_030717.pdf. August 15, 2017.
- 5** DVRPC (2017). Philadelphia Delivery Handbook. Delaware Valley Regional Planning Commission, Philadelphia, PA. Accessed from: <http://www.dvrpc.org/Reports/16012.pdf>. August 15, 2017.
- 6** Burks, S., Belzer, M., Kwan, Q., Pratt, S., and Shackelford, S. (2010). Trucking 101: An Industry Primer. Transportation Research Circular E-C146, Transportation Research Board of the National Academies of Sciences, Engineering, and Medicine, Washington, DC.
- 7** City of Portland (2017). "Portland Freight Committee." Bureau of Transportation, City of Portland, Portland, OR. Accessed from <https://www.portlandoregon.gov/transportation/article/357102>. August 15, 2017.
- 8** Central London Freight Quality Partnership (n.d.). "London's Freight Quality Partnerships." Central London Freight Quality Partnership Website, Central London Freight Quality Partnership, London, UK. Accessed from: <https://www.centrallondonfqp.org/>. August 15, 2017.
- 9** Wilbur Smith Associates and S.R. Kale Consulting (2010). *A Guidebook for Engaging the Private Sector in Freight Transportation Planning*. Prepared for the Federal Highway Administration, US Department of Transportation, Washington, DC.
- 10** Mulcahy, D., and Dieltz, J. (2004). Order-Fulfillment and Across-the-Dock Concepts, Design, and Operations Handbook. St. Lucie Press, New York, NY.
- 11** FHWA (2015). Compilation of Existing State Truck Size and Weight Limit Laws. Report to Congress, May 2015. Federal Highway Administration, US Department of Transportation, Washington, DC. Accessed from: https://ops.fhwa.dot.gov/FREIGHT/policy/rpt_congress/truck_sw_laws/truck_sw_laws.pdf. August 15, 2017.
- 12** NYC DOT (2017). "Size and Weight Restrictions." NYC DOT Website, New York City Department of Transportation, New York, NY. Accessed from: <http://www.nyc.gov/html/dot/html/motorist/sizewt.shtml>. August 15, 2017.
- 13** FHWA (2015)
- 14** FHWA (2015)
- 15** NYC DOT (2017)
- 16** NYC DOT (2015). *2015 New York City Truck Route Map*. New York City Department of Transportation, New York, NY. Accessed from: <http://www.nyc.gov/html/dot/downloads/pdf/2015-06-08-truck-map-combined.pdf>. August 15, 2017.
- 17** Seattle DOT (2016). "Downtown Traffic Control Zone Map." Seattle Department of Transportation Website, City of Seattle, Seattle, WA. Accessed from: <https://www.seattle.gov/transportation/dtczmap.htm>. August 15, 2017.
- 18** European Union and Sadler Consultants, Ltd. (2016). "Low Emissions Zones." Urban Access Regulations in Europe Website, European Union and Sadler Consultants, Ltd., Bristol, UK. Accessed from: <http://urbanaccessregulations.eu/low-emission-zones-main>. August 15, 2017.
- 19** Browne, M. J., Allen, J., and Leonardi, J. (2011). Evaluating the Use of an Urban Consolidation Centre and Electric Vehicles in Central London. *IATSS Research*, Vol. 35, p. 1-6.
- 20** Dablanc, L. and Montonen, A. (2015). Impacts of Environmental Access Restrictions on Freight Delivery Activities: The Example of Low Emission Zones in Europe. *Transportation Research Record: Journal of the Transportation Research Board*, No. 2478. p. 12-18.
- 21** Morris, A.G. (2009). Developing Efficient Freight Operations for Manhattan's Buildings. The Stephen L. Newman Real Estate Institute, Baruch College, New York.
- 22** Conway, A., N. Tavernier, V. Leal-Tavares, N. Gharahmani, L. Chauvet, M. Chiu, and X. Yeap. (2016). Freight in a Bicycle-Friendly City: An Exploratory Analysis. *Transportation Research Record: Journal of the Transportation Research Board*, No. 2547. p. 91-101.

2 Fundamentals of Emergency Services

Society depends on emergency service providers to maintain public health, safety, and order. On a daily basis, police, firefighters, emergency medical technicians and paramedics, and other emergency service providers respond to personal medical emergencies, fires, crimes, traffic collisions, and other incidents that put local residents at risk. Occasionally, emergency service providers must also respond to major natural and man-made catastrophic events such as severe weather incidents, train derailments, hazardous material spills, and terrorist attacks. Whether responding to a minor or major event, the goal of an emergency service provider is to reach an incident location safely and as quickly as possible to provide the required assistance and reduce the detrimental impacts of the incident. Depending on the type and location of an event, common detrimental impacts may include injury, death, or other public health effects; property or environmental damage; and travel delay or traffic congestion. When responding to a life-threatening emergency such as a patient in cardiac arrest, a crime involving a perpetrator with a weapon, or a quickly spreading fire, small increases in response time can result in increased injury severity or loss of life. Delayed response time can also result in greater property damage; for example, a 2005 Boston Globe investigation found that damage costs from house fires increased from \$27,000 if firefighters arrived within three minutes to \$61,000 if arrival took nine minutes or more.¹

Planning for emergency access first requires an understanding of emergency service operations and access needs. The following sections provide a brief introduction to the demand for emergency services in a community; the stakeholders who provide these services; the vehicles used to transport personnel, equipment, and patients; the infrastructure needed to support these operations; the local regulations that may influence behavior; and finally, the common challenges that emergency service providers often face when operating on multimodal streets.

2.1 Demand for Emergency Services

Demand for emergency services will depend on incident frequencies, which will vary considerably with characteristics of the local population, built environment, and natural environment. For the purpose of analyzing 911 response, New York City defines 10 major types of incidents to which the New York Police Department (NYPD), Fire Department of New York (FDNY), and FDNY Emergency Medical Services (EMS) must respond;² these include:

- ◆ “Critical crimes in progress (NYPD): shots fired, assist police officer, robbery, burglary, larceny from person, assault w/ knife, assault w/ weapon, unusual incident;

- ◆ Serious crimes in progress (NYPD): auto theft, other larceny, other assault, roving band
- ◆ Non-critical crimes in progress (NYPD): other crimes not included in above categories
- ◆ Non-crimes in progress (NYPD): incidents that do not constitute a crime in progress; including, but not limited to, crimes that occurred in the past and incidents that are in NYPD’s jurisdiction but are not criminal in nature
- ◆ Structural fires (FDNY): commercial building, residential building, public building, vacant building
- ◆ Non-structural fires (FDNY): brush fire, auto fire, transit system fire, etc.
- ◆ Medical emergencies (FDNY): cardiac arrest, choke, anaphylactic shock, major burn, etc.
- ◆ Life threatening medical emergencies (FDNY EMS): cardiac arrest, choke, anaphylactic shock, major burn, etc.
- ◆ Non-life threatening medical emergencies (FDNY EMS): drug overdose, sick, pain, etc.
- ◆ Non-medical emergencies (FDNY): clogged incinerator, odor, vehicle accident, etc.”

The likelihood or severity of each of these incident types will vary considerably depending on local factors. For example, cardiac arrest incidents will be more likely in areas with larger populations of seniors.³ Drug overdose incidents

will occur in regions facing a drug epidemic.⁴ Structural fires are more likely to reach a point of flashover in old buildings not equipped with sprinkler systems;⁵ fires are more likely to spread to adjacent buildings in areas with high winds and high building densities. Traffic collision frequencies may be elevated by a variety of roadway, operator, or weather characteristics. While a detailed discussion of the variables driving incident frequencies is beyond the scope of this guidebook, planners should recognize local trends in incidents and communicate with local emergency service providers regarding expected impacts of these trends on system demand and on locations of potential hotspots.

2.2 Emergency Service Providers

The three primary types of emergency services in most municipalities are emergency medical services, fire protection, and policing.

Emergency Medical Services (EMS)

Emergency Medical Service providers treat patients in crisis health situations and transport them to hospitals for treatment. In general, there are three classes of EMS providers: emergency medical technicians, who provide generally non-invasive basic life support treatments (BLS); paramedics, who have significantly more training and provide invasive advanced life support treatments (ALS); and in some areas, EMT-Inter-

mediates, who can provide some but not all ALS treatments.⁶ EMS may be housed within a fire or police department, provided by an independent government entity, or provided by independent operators under contract to a municipality. Services may also be provided by non-profit volunteer organizations in some areas.

Fire Departments and Districts

The agency structure for fire protection can vary from state to state. In New York, fire protection services are provided by municipal fire departments in most cities and villages, and by fire districts in less densely populated areas.⁷ A fire district is a public corporation that provides fire protection services in one or more towns and is governed by an independent elected body. Fire departments and districts are responsible for providing firefighting services and other types of emergency response. Fire departments in large cities are typically staffed by paid career professionals; smaller communities may depend exclusively on volunteers, or may rely on volunteers to support paid personnel.

The complexity of a fire department will vary as a function of its size, but departments typically include the same basic structure. Fire engine, truck, and ladder companies are the individual personnel units responsible for operating specific apparatus. A company will typically include a lieutenant, who oversees company operations, a driver engineer or chauffeur—who drives and performs other operational functions of the fire

apparatus such as deploying aerial equipment, and firefighters, who conduct firefighting activities.⁸ Multiple companies may be located in a station, which is overseen by a captain, and multiple stations make up a battalion, which is overseen by a battalion chief. Specialized units may also be trained to provide specific functions such as hazmat response, water rescues, etc. In general, a fire chief is the operational leader of a fire department, overseeing all departmental operations. In very large cities like NYC, a civilian fire commissioner may also be appointed.

Police Departments

Police are responsible for enforcing laws, maintaining public safety, and managing traffic.⁹ Police services may be provided by municipal police departments, county sheriffs, or state police departments. Like fire departments, police departments are typically organized in a complex hierarchical structure, with a chief as the highest ranking uniformed officer, and in larger cities, an appointed civilian commissioner who may oversee the department. Police departments can be divided into bureaus by function and may also have specialized units that provide specific services. On-the-ground patrol officers are typically associated with a defined geographic area of responsibility called a district or precinct. In some cities like New York, police are responsible for enforcing parking regulations; in other cities like Philadelphia, this task is designated to an independent authority.

Other Emergency Service Providers

In addition to the three major categories of emergency service providers, additional responders may operate locally to respond to specific incident types. For example, according to New York State traffic law, other emergency responders may include corrections officers, military and civil defense authorities, blood transporters, environmental emergency and hazardous materials (hazmat) responders, and sanitation patrols.¹⁰

Stakeholder Engagement

Planners can proactively identify potential operating challenges for local emergency service providers through direct engagement with relevant experts. However, outreach plans should be developed with cognizance that staff resources in fire departments, police departments, and professional or volunteer organizations providing EMS services may be constrained. Depending on the specific information required, planners may conduct outreach to different entities. For example, within a large fire department, driver engineers can provide detailed information about the specifications and functions of a specific apparatus and discuss experience operating the vehicle. Battalion chiefs, captains, and lieutenants are likely to be familiar with local operations in a designated area. A fire chief or fire commissioner may have statutory authority to regulate roadway designs or operations on a fire access route (see section 2.5).



NYPD vehicle on Brooklyn Bridge ped/bike path

Some specific methods of outreach that have been implemented in U.S. cities include:

- ◆ Targeted invitations to public meetings
- ◆ Regularly scheduled meetings with emergency personnel to review project plans
- ◆ Inclusion of emergency personnel as part of a project technical advisory committee

2.3 Emergency Service Vehicles

In large municipalities, emergency service providers may operate fleets that include thousands of vehicles ranging from bicycles to large trucks; these fleets may include a tremendous variety of specialized vehicles that serve very specific functions. In smaller municipalities, operators are more likely to use versatile vehicles that may serve multiple purposes. This section details only the most commonly used emergency vehicles; however, in determining appropriate design or control vehicles, planners and designers should consult with local operators regarding the specific vehicle types used in a local area.



Clockwise from upper left: Chassis with integrated cab ambulance body; Cutaway van with modular ambulance body; Engine; Aerial platform truck

Ambulances

The Commission on the Accreditation of Ambulance Services defines three different ambulance types: a chassis with an integrated cab body, a cab-chassis with a modular ambulance body, and a cutaway van with a modular ambulance body.¹¹ The former is typically only used to provide BLS while the latter two are more commonly used to carry equipment for ALS. The length and weight of the vehicle may increase depending on the amount of equipment to be carried on-board.

Fire Apparatus

Usually the largest emergency vehicles operating in a community will be fire apparatus. Common fire apparatus include engines (pumpers), foam pumpers, tankers (water tenders), and aerial ladders, platforms (tower ladders), and tillers.¹² Engines carry personnel and equipment to the scene of a fire, and carry only enough water to start operations at an incident location.¹³ Foam pumpers carry foam, which is used to cool a fire. Tankers carry larger volumes of water for continuing operations. Aerial ladder trucks carry straight ladders required to conduct operations at tall building incidents. Aerial platforms include a platform (bucket) that provides a flat surface where firefighters may stand during firefighting or rescue operations. These platforms enable firefighters to use higher capacity water streams at elevated heights.¹⁴ Aerial tiller trucks are articulated vehicles with separate front and rear

steering that allows for improved navigation of tight turns.¹⁵ Fire departments may also use a variety of specialized trucks for operations such as hazmat response and rescue from severely damaged vehicles. For detailed discussion of fire apparatus vehicle dimensions, readers are referred to the *International Association of Fire Chiefs/Fire Apparatus Manufacturers Association Emergency Vehicle Size and Weight Regulation Guideline*.¹⁶

Police Vehicles

Police patrol operations are typically conducted using passenger vehicle configurations such as sedans, SUVs, and passenger vans. More pedestrian-friendly vehicles, bicycles, and even horses may be deployed in low-speed areas such as parks or other pedestrian-only zones. Larger vehicles such as buses, armored trucks, and even boats can serve specific functions such as prisoner transport, SWAT, or water rescue.

2.4 Emergency Response Infrastructure

Emergency Service Buildings

Fire stations and police stations are buildings where engine and ladder companies and police officers are headquartered. Fire apparatus are typically stored inside of a fire station structure; police vehicles may be stored on street in front of a station or in an off-street lot or garage.

Hospitals are institutions that provide medical treatment.

Fire Lane/Fire Access Road

According to the NYC fire code, a fire lane is a road, travel lane, parking lot lane, or other surface on public or private right-of way that provides access for a fire apparatus to reach a building.¹⁷ A fire access road connects a building not fronting a public street to that public street.¹⁸

Fire Hydrants

A fire hydrant is a pipe by which a hose can be connected to a water source. Firefighters must connect to a water source that allows adequate water flow for attacking a fire.¹⁹ Fire hydrants are typically located at the curbside, but can also be wall mounted in some locations.

Frontage Space

Open space is required at building entrance locations to provide clearance for emergency service provider staging and operations. The NYC Fire Code mandates that frontage space must be provided that is “not less than 30 feet in any dimension that is accessible from a public street or fire apparatus access road, provides access to the building, and serves as a staging area for firefighting and other emergency operations.”²⁰ Snyder et al. identify a number of individual fire response tasks that may require space; these include opening doors of vehicles and storage compartments, accessing equipment and ladders, connecting hoses, deploying



*Above: Ladder Truck With Aerial stabilizer
(Source: “Christiana Fire Company, Delaware - Ladder 3-7 ‘Quint’” (CC BY-NC 2.0) by Timothy Wildey)*

Right: Fire hydrants



ladders, and deploying stabilizers for aerial equipment.²¹ These authors note that depending on the specific vehicle type and the characteristics of a building and incident, aerial stabilizers may need to extend up to 18 feet from a truck.

2.5 Emergency Service Regulations

A number of types of local regulations can affect emergency operations in a local area.

Fire Access Regulations

Typically, the local fire code, which is often adapted from the International Fire Code,²² outlines requirements for fire access, including specific design specifications such as minimum roadway width, maximum roadway grade, and loading capacities on fire access lanes or roads. It also details requirements for frontage space at an incident location for vehicle staging and clearances required around fire hydrants and other water access points. For example, in NYC, the fire code requires a general minimum roadway width of 34' with 18' of usable roadway, a maximum roadway grade of 10 percent, a 30' x 30' frontage space for staging, and a clear radius of 3' around fire hydrants.²³ The fire code may also grant specific powers to a fire commissioner or chief on these routes. For example, according to the NYC Fire Code, the commissioner can determine a minimum turning radius and can restrict parking “on fire apparatus roads where

the angle of approach, curvature of the road, or other roadway configuration or site conditions impede the ability of fire apparatus to make turns or otherwise navigate the fire apparatus access road.”

Operating Exceptions

State and local traffic regulations usually include exceptions that permit responding emergency vehicles with flashing lights and auditory signals to disobey typical regulations. For example, New York State law permits an authorized emergency vehicle to stop in a non-permitted location; proceed past a red signal; exceed a speed limit; and disregard directionality and turning movement restrictions while responding to a life-threatening emergency, although the operator is still required to drive “with due regard for the safety of all persons.” State or local traffic laws also typically mandate that other travelers yield to emergency vehicles.

Performance Standards

The National Fire Protection Association (NFPA) has established performance standards for both fire and emergency medical service response. NFPA 1710 establishes expected services, staffing levels, and service times for both EMS and fire response in areas with career service providers;²⁴ NFPA 1720 also establishes expected services, staffing levels, and service times for fire response in areas with volunteer providers.²⁵ One component of these standards is the response time, which is the time from the



Painted curb to indicate parking prohibited

completion of dispatch to arrival at an incident location. For EMS response, the standard is based on historic outcomes for a patient in cardiac arrest. For fire response, the standard is based on expected time to fire flashover—which is the time when all flammable materials in a room spontaneously ignite due to thermal radiation feedback.²⁶

The standards define a maximum expected arrival time that should be met for a defined share of incidents and vary depending on the density

of the area served and on whether the local emergency service providers are career professionals or volunteers.²⁷ For emergency medical service providers, two minimum response times are defined: arrival of a first responder with an automatic external defibrillator to provide BLS, and arrival of an ALS team. In an area with professional EMS, the first responder is expected to arrive to an incident within four minutes, and an ALS team within eight minutes. This standard is expected to be met for 90 percent of incidents. For fire response, two minimum response times



Paint on street to indicate parking prohibited across from fire station

are also defined: arrival of the first engine, and arrival of a “full alarm,” which includes specific vehicles, equipment, and personnel for full response. In an area with a professional fire department, the first engine is expected to arrive within four minutes, and the “full alarm” within eight minutes. For volunteer companies, expected “full alarm” arrival times range from nine minutes in urban areas to 14 minutes in rural areas, with a lower expected success rate of 80 percent in suburban and rural areas.

There is considerable debate in the medical community about the appropriateness of using response time as a performance measure, as not all emergencies require the same speed of response as the critical cases considered in standard development.²⁸ Nonetheless, these NFPA standards may be formally adopted by local regulatory authorities, may be adopted as part of a contract with a private service provider, or may simply serve as voluntary guidelines. Operators who fail to meet this standard may be subject to fines or litigation. For example,

in 2015, the City of San Diego fined a private ambulance operator \$230,000 for failing to meet contractually obligated response time standards.²⁹ Even in areas where the standards are voluntary, the law may allow individuals or municipalities to sue providers for negligence if they fail to meet an expected standard of care.³⁰

Parking Regulations

Parking regulations typically maintain vehicular access on fire access lanes and routes and maintain clearances at fire hydrant locations. As discussed above, a local fire chief or commissioner may have authority to prohibit parking in restricted locations such as on curved access roads or in a location that provides access to a fire house. In New York, the City’s *Traffic Rules* prohibit parking within 15 feet of a fire hydrant.

Truck Size and Weight Regulations

In many cities and states, fire apparatus are specifically exempted from truck size and weight regulations (see section 1.5); however, in some states and municipalities, these regulations still apply. Independent regulations may also exist. For example, in NYC, length and axle weight limits do not apply to fire apparatus, but vehicles may not exceed local gross vehicle weight maximums.³¹ Fire vehicles are also permitted to be 98 inches wide compared to a general vehicle limit of 96 inches.

2.6 Common Emergency Operator Challenges in Complete Streets Areas

Emergency service providers face a number of challenges in Complete Streets areas. Like large commercial truck operators, large emergency vehicle operators face challenges navigating restricted turns, narrow lanes, and curved or circular travel paths. Particularly in areas where pedestrians and bicycles are operating, emergency response vehicles traveling at high speeds to an incident location can present a dangerous collision risk; however, drivers must weigh this risk against the potential for loss of life due to slow incident response times. Raised speed reducers not only slow response times, but can also cause injury to on-board patients or personnel and can damage onboard equipment. Similarly, changes in directionality or infrastructure that physically prevents turning movements such as crossing a median can increase the distance and time required for incident response. Road diets and other types of

lane narrowing that physically reduce roadway widths or eliminate two-way left-turn lanes can remove redundant capacity used by emergency responders to bypass congested traffic. Curb bumpouts and other curbside infrastructure such as barrier-protected bicycle lanes can increase the distance between a building and a fire apparatus, which can be especially problematic for the use of aerial ladders and platforms. Curbside and sidewalk barriers can impede building access and aerial equipment deployment for fire operations and building access for ambulance operators transporting patients and equipment.

Chapter 3 discusses these challenges in detail, and provides design, operational, and regulatory approaches that can be implemented to address them.

Endnotes

- 1** Dedman, B. (2005). "Slower arrival at fires in US is costing lives." *Boston Globe*, January 30, 2005.
- 2** City of New York (2014). "Incident Type Definitions." NYC Analytics Website, City of New York, NY. Accessed from: <http://www.nyc.gov/html/911reporting/html/reports/incident-type-definitions.shtml>. August 15, 2017.
- 3** Aldrich, C., Hisserich, J., and Lave, L. (1971). An Analysis of the Demand for Emergency Ambulance Service in an Urban Area. *American Journal of Public Health*, Vol. 61, No. 6. p. 1156–1169.
- 4** Garza, A., and Dyer, S. "EMS Data Can Help Stop the Opioid Epidemic." *Journal of Emergency Medical Services*, November 1, 2016. Accessed from: <http://www.jems.com/articles/print/volume-41/issue-11/features/ems-data-can-help-stop-the-opioid-epidemic.html>. August 15, 2017.
- 5** Snyder, R., Siegman, P., Huff, H., and McCormick, C. (2013). Best Practices: Emergency Access in Healthy Streets. Los Angeles County Department of Public Health, Los Angeles, CA. Accessed from: <https://www.cnu.org/sites/default/files/Best-Practices-Emergency-Access-in-Healthy-Streets.pdf>. August 15, 2017.
- 6** EMS1 (2017). "What is EMS: A Definition." EMS1.com Website, EMS1.com. March 6, 2011. Accessed from: <https://www.ems1.com/careers/articles/1058440-What-is-EMS-A-Definition/>. August 15, 2017.
- 7** AFDSNY (2017). *Basic Fire Department Structure*. Association of Fire Districts of the State of New York, February 22, 2017. Accessed from: http://www.afdsny.org/docs/020317_Basic_Fire_Department_Structure_December_5_jff.pdf. August 15, 2017.
- 8** FireRescue1 (2016). "What are the firefighter ranks?" FireRescue1.com Website, FireRescue1.com, September 26, 2016. Accessed from: <https://www.firerescue1.com/fire-careers/articles/128812018-What-are-the-firefighter-ranks/>. August 15, 2017.
- 9** NYPD (2016). "About NYPD." NYPD Website, Police Department, City of New York, NY. Accessed from: <http://www1.nyc.gov/site/nypd/about/about-nypd/about-nypd-landing.page>. August 15, 2017.
- 10** Consolidated Laws of the State of New York, Vehicle and Traffic Law §1-1-101
- 11** CAAS (2016). *Ground Vehicle Standard for Ambulances*, v 1.0. Commission on Accreditation of Ambulance Services, Glenview, IL.
- 12** IAFC and FAMA (2011). *Emergency Vehicle Size and Weight Regulation Guideline*. International Association of Fire Chiefs, Fairfax, VA, and Fire Apparatus Manufacturers Association, Ocala, FL. Accessed from: https://fama.org/wp-content/uploads/2015/09/1441593313_55ecf7e17d32d.pdf. August 15, 2017.
- 13** FDNY (2016). *Probationary Firefighters Manual*, Vol. 1. Fire Department, City of New York, NY. Accessed from: <http://www1.nyc.gov/assets/fdny/downloads/pdf/join/join-Probie-Manual.pdf>. August 15, 2017.
- 14** FDNY (2016).
- 15** *ibid*
- 16** IAFC and FAMA (2011).
- 17** New York City Fire Code (2014). Chapter 5: Fire Operations Features, Section 502.1.
- 18** *ibid*
- 19** FDNY (2016).
- 20** New York City Fire Code (2014). Chapter 5: Fire Operations Features, Section 502.1.
- 21** Snyder et al. (2013)
- 22** ICC (2015). *International Fire Code*. International Code Council, Washington, DC.
- 23** New York City Fire Code (2014). Chapter 5: Fire Operations Features, Sections 502.1, 503.2.2.3, 503.2.3.
- 24** NFPA (2016a). *NFPA 1710: Standard for the Organization and Deployment of Fire Suppression Operations, Emergency Medical Operations, and Special Operations to the Public by Career Fire Departments*. National Fire Protection Association, Quincy, MA.
- 25** NFPA (2016b). *NFPA 1720: Standard for the Organization and Deployment of Fire Suppression Operations, Emergency Medical Operations and Special Operations to the Public by Volunteer Fire Departments*. National Fire Protection Association, Quincy, MA.
- 26** Flatley, C. (2005). "Flashover and Backdraft: A Primer." *Fire Engineering*, March 1, 2005. Accessed from: <http://www.fireengineering.com/articles/2005/03/flashover-and-backdraft-a-primer.html>. August 15, 2017.
- 27** IAF and IAFC (2002). *NFPA 1710 Implementation Guide*. International Association of Fire Fighters, Washington, DC, and International Association of Fire Chiefs, Fairfax, VA.
- 28** McCallion, T. (2012). "The Great Ambulance Response Time Debate Continues." *Journal of Emergency Medical Services*, February 16, 2012. Accessed from: <http://www.jems.com/articles/2012/02/great-ambulance-response-time-debate.html>. August 15, 2017.
- 29** McDonald, J. (2015). "City fines ambulance firm \$230,000." *The San Diego Union-Tribune*, October 20, 2015.
- 30** NVFC and NFPA (2012). *Understanding & Implementing Standards: NFPA 1500, 1720, and 1851*. National Volunteer Fire Council, Greenbelt, MD, and National Fire Protection Association, Quincy, MA.
- 31** Rules of the City of New York, Title 34, Chapter 4, Section 15: Limitations Upon Dimensions of Vehicles.

3 Street Design and Management Considerations

3.1 Selecting an Appropriate Design and Control Vehicle

Designing for large truck or emergency vehicle movements in densely developed or mixed-use areas is a challenge, as the wide roadways preferred for unimpeded navigation by these vehicles are unappealing to and, in many cases, unsafe for use by pedestrians and bicyclists. Accommodating freight parking and loading activities and emergency operator staging and response is also difficult in areas where space is constrained and where competition with other modes is high. Yet, failing to consider freight and emergency vehicle activities in design of facilities can result in motor vehicle lane obstructions that cause traffic congestion and related emissions; bicycle lane and sidewalk encroachments that can elevate the risk of collisions with non-motorized travelers; unsafe operating conditions for delivery persons, emergency personnel, and patients; damage to vehicles, loads, infrastructure, and roadside property; and unacceptable emergency response times.

A key first step in designing infrastructure for freight and emergency operations is identifying the vehicle types likely to undertake these functions in a project area and understanding the operating characteristics of these vehicles as drivers navigate the street network and conduct daily activities. First- and last-mile freight typically moves by truck or van, but the specific vehicle types (see section 1.3) and their

size and frequency, vary greatly depending on the local industries and businesses that generate trips (see section 1.2), the characteristics of the supply chains that serve this demand, and local regulations (see section 1.5). Emergency vehicles can also vary considerably in size and maneuverability from municipality to municipality and depending on their specific function (see section 2.3).

3.1.1 Critical Vehicle Dimensions

A number of vehicle dimensions are important to consider when designing intersections, travel lanes, and parking and loading spaces for freight and emergency vehicles in densely developed areas:

- ◆ Vehicle wheelbase affects the minimum acceptable turning radius at intersections, driveways, and loading docks.
- ◆ Vehicle length affects the minimum parking length that should be provided in curbside spaces, at loading docks, or off-street, and also impacts the minimum acceptable turning radius.
- ◆ Vehicle width affects the minimum acceptable travel and parking lane and loading dock widths.
- ◆ Vehicle height affects the minimum clearance that must be provided under vertical obstructions, including roadway barriers such as bridges, signage, and signals, as well as curbside barriers such as lighting, signage, and trees.



Cab over engine truck

3.1.2 Design Vehicle vs. Control Vehicle

In the traditional American Association of State Highway and Transportation Officials (AASHTO) roadway design method, a design vehicle is the largest vehicle expected to frequently use a roadway.¹ AASHTO has identified typical dimensions—including length, width, wheelbase, and height—to represent a variety of common design vehicle types. Once a design vehicle is identified, a roadway’s minimum dimensions are determined based on that vehicle’s size and operating characteristics. Other recent street design guidelines, such as the NACTO Urban Street Design Guide,² distinguish between a design vehicle and a control vehicle. A control vehicle is an occasional user of the street that may be larger than the design vehicle. To accommodate necessary large vehicle movements while minimizing the physical space required, recent design guides recommend consideration of an expected travel path.³ While an urban street should be designed to accommodate the operation of a design vehicle without encroachment into space dedicated for another mode or movement during typical operations, a control vehicle may be permitted to encroach on infrastructure typically used by another mode or movement. For example, occasionally allowing a large truck to cross into an adjacent (see section 3.5) or oncoming (see section 3.8) lane or to mount a curb (see section 3.9) to navigate a tight turn may be a preferable solution compared to providing wide travel lanes and a large curb



Fuel truck

radius, which increase pedestrian crossing distances at all times.

3.1.3 Existing Recommendations

In a dense, mixed use environment, the design vehicle is usually a freight-carrying truck or school bus. Compared to a passenger car, these vehicles are longer and heavier, with wider wheelbases and axles. A large truck may also be articulated, with a joint connecting its steering unit and trailer. Articulated trucks can off-track during a turning movement; usually, the inside rear trailer tire follows a much narrower turning

path that the outside front tire of the steering unit.⁴ On some specialized vehicles, such as an aerial tiller truck (see section 2.3), separate rear steering may reduce off-tracking.

AASHTO design vehicles typically used to represent freight operations in dense environments range from a single unit truck (SU-30) to a 53-foot Interstate semitrailer (WB-67). Recognizing that the smallest AASHTO design truck, the SU-30, may be oversized for freight operations in some locations, NACTO introduced a new design vehicle, a small delivery truck (DL-23).

NACTO recommends use of the DL-23 for designing neighborhood and residential streets.⁵

In an emergency response situation, emergency vehicles are often permitted priority use of all street space, including areas designated for alternative transportation modes (e.g., bus lane, bicycle lane); as a result, emergency vehicles can often be considered as control vehicles rather than design vehicles. AASHTO does not provide dimensions for typical emergency vehicles; however, street designers can coordinate with local fire officials to determine the dimensions of locally operating vehicles, and where possible, to identify AASHTO design vehicle equivalencies. For example, in Portland, Oregon, the WB-40 was identified as an equivalent vehicle to a city fire truck,⁶ and in Amherst, Massachusetts AASHTO's intercity bus was identified as equivalent to an aerial platform truck.⁷

Common design vehicles

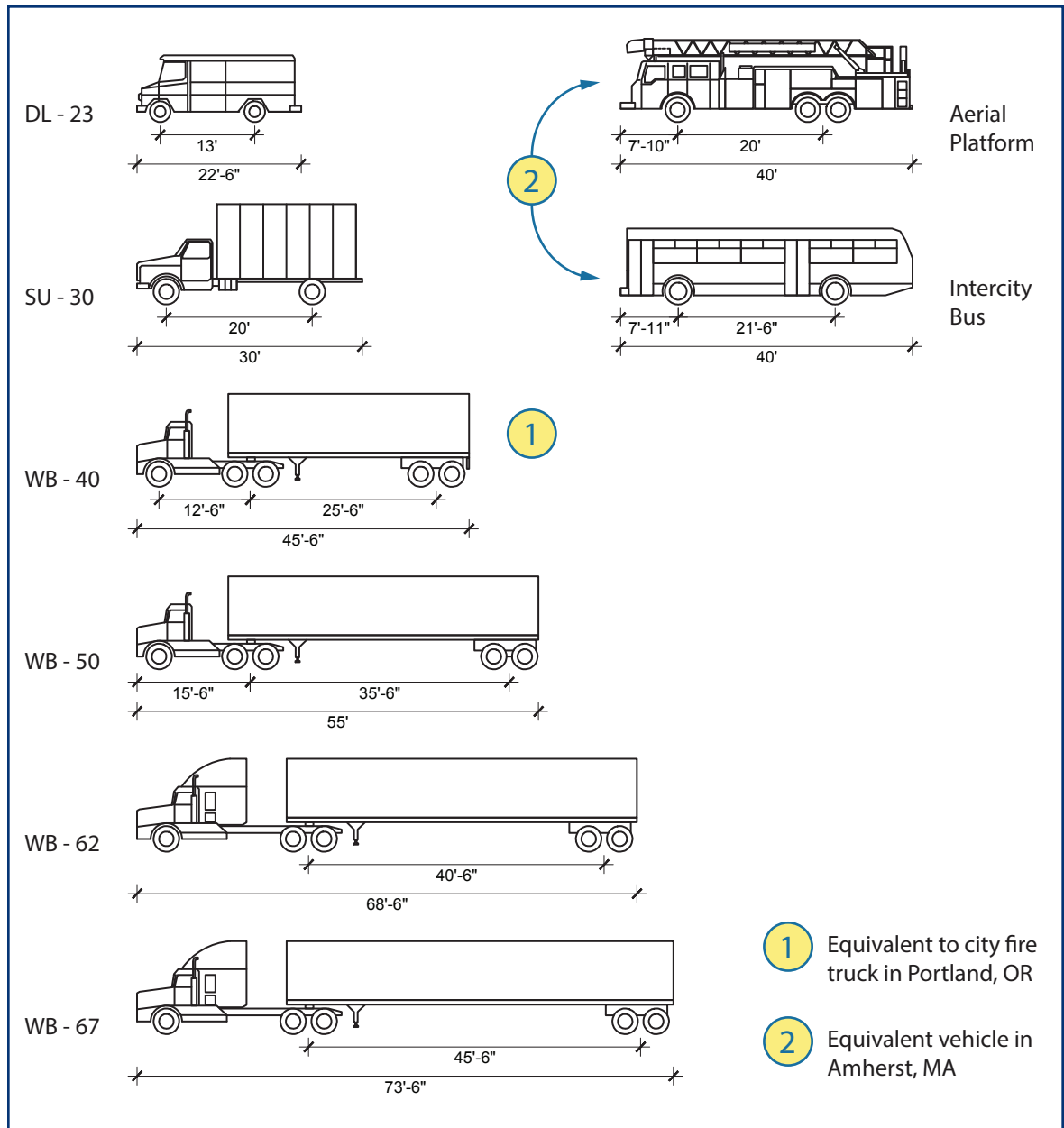

3.1.4 Selection Criteria

Caution should be exercised in applying general recommendations for selection of freight or emergency design and control vehicles. As discussed in Chapter 1, freight activity is generated by many different land uses, and many factors impact the types of vehicles used locally. In areas with mixed development, commercial and even industrial land uses may be adjacent to residential developments. While large semi-trailers are not common in dense downtown districts, they may visit major retailers such as department stores, groceries stores, and big-box chains in these areas. Other business types such as gas stations or car dealerships may require occasional trips with specialized vehicles. In each of these situations, larger than typical control vehicles may be required. The flexibility of a street design to adapt to changes in goods movement should also be considered, as business turnover or supply change reorganization can quickly change the nature of freight activity in an individual location. Given the complexity of local freight operations and the potential consequences of under-designing for large vehicles, freight design and control vehicle selection should consider several factors, including

- ◆ Current or expected future freight trip generating land uses in the surrounding area, including industrial land uses such as manufacturing and warehousing as well as commercial and residential activities that rely on freight deliveries
- ◆ Local truck size and weight regulations (or applicable federal or state regulations)
- ◆ Current or expected freight traffic flows (ideally vehicle classification counts), and general traffic conditions
- ◆ Street network designations, including highway functional classifications as well as any freight-specific functions
- ◆ Historic data, such as collision records, for incidents involving freight vehicles

Both the City of Portland⁸ and the Florida Department of Transportation⁹ have published local guidelines for selecting design vehicles depending on the freight use of a roadway.

To determine an appropriate design or control vehicle for emergency operations, agencies should consult directly with the local emergency personnel (see section 2.2) and should review local regulations (see section 2.5) to determine:

- ◆ The types and dimensions of vehicles—especially fire apparatus—in a municipality’s fleet
- ◆ The locations of designated fire access routes
- ◆ The authorities granted to the fire chief or commissioner in the local fire code to regulate fire lanes and access roads
- ◆ The operating exceptions granted for emergency vehicles in state or local traffic laws

3.2 Providing Adequate Space for Safe Large Vehicle Turns

Several types of turning movements may be a challenge for large commercial and emergency vehicles to perform in densely developed areas; these include:

- ◆ Intersection turning movements
- ◆ Mid-block turning movements into driveways, loading docks, and alleys
- ◆ Entrance to, navigation of, and exit from traffic circles and roundabouts

On pedestrian-friendly streets, narrow travel lanes and small corner radii provide short crossing distances that minimize pedestrian exposure to vehicle conflicts. However, large vehicles may have difficulty navigating the resulting narrow travelway. On many mixed-use street raised median islands, corner bulbouts, and neckdowns are implemented to shorten pedestrian crossing distances and discourage speeding;¹⁰ these treatments can sometimes present a barrier to a large vehicle turn. Other vehicles parked too close to an intersection, driveway, or loading dock entrance, whether legally or illegally, can also impede a wide turning path.

If adequate space is not provided for turning movements, large vehicles will encroach into adjacent lanes or onto raised curbs, or may



Intersection neckdown

simply be unable to navigate a route. Encroachment can result in an unexpected conflict with a vulnerable roadway user, while inability to pass may result in costly delays, missed deliveries, and slowed emergency response. Impact with a raised curb can also present a hazard; vehicles, loads, or equipment can become damaged or unbalanced;¹¹ and onboard personnel¹² or patients¹³ could be injured.

The following pages describe a number of approaches that can be implemented to ensure adequate turning paths for large freight and emergency vehicles where space is limited, including design, regulatory, and traffic operations approaches. Design solutions should be considered in the context of local agency guidelines. Solutions not currently adopted into street design standards may be considered as pilot treatments.

3.2.1 Curbside Parking Lanes

Roadway designs that maintain curbside parking, or alternative curbside uses such as bike-share stations or parklets, can provide space for a large effective turning radius at intersections, mid-block driveways, and loading dock entrances. The extra space provided between the vehicle and the curb allows the vehicle to take a wider turning path than would be allowable for a movement directly from a curbside travel lane. Maintaining an on-street parking lane can result in a relatively wide roadway; however, bulbs can be implemented to shorten pedestrian crossing distances at intersections and to maintain online transit loading.¹⁴

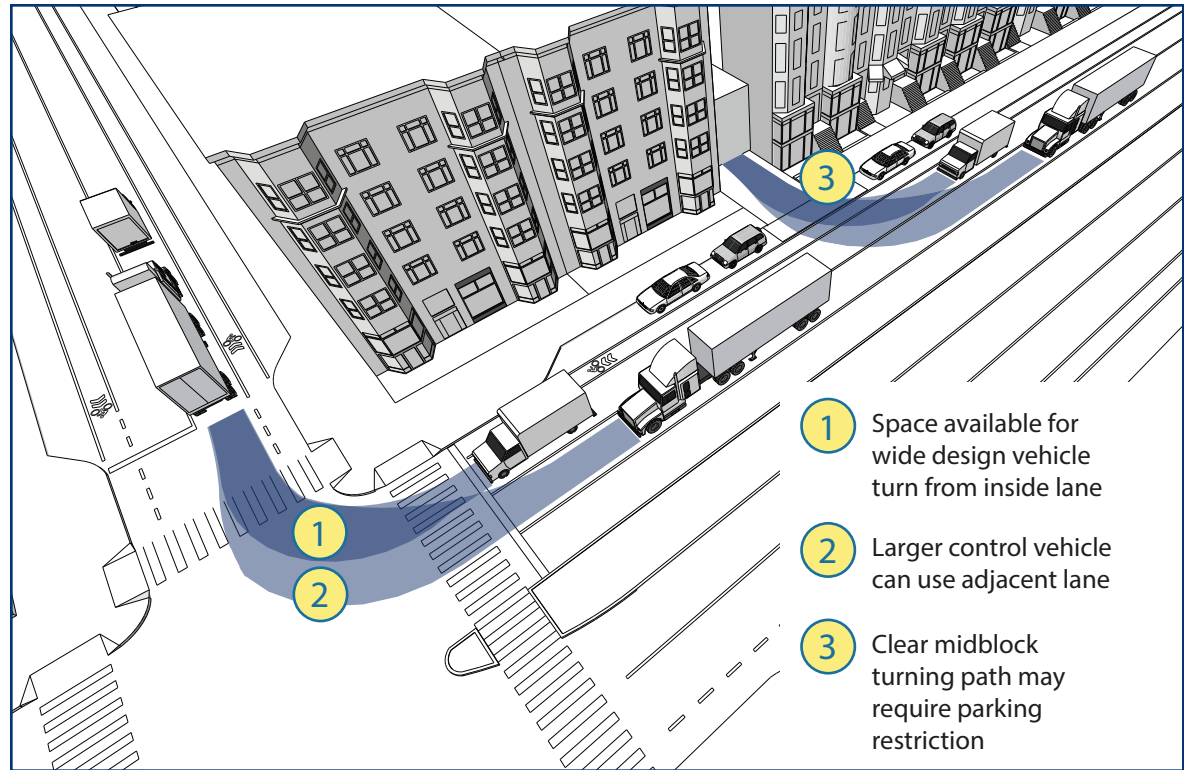

Curbside parking lane diagram

3.2.2 Curbside Bicycle Lanes

Roadway designs that maintain curbside bicycle lanes can also provide extra space for a large effective turning radius. If turning vehicles are expected to cross or encroach on segments of the bicycle lane, areas where a conflict may occur should be clearly marked to raise awareness of cyclists to vehicle operators and to warn cyclists of a potential conflict. Curbside bike lanes can benefit emergency vehicle access by maintaining an open curb; however, if the bike lane is separated from the travel lane by a raised barrier, explicit consideration should be given to fire hydrant and building access requirements (see section 2.5). However, despite these turning radius benefits, curbside bike lanes can also present a challenge for freight loading activity as they often eliminate direct curbside access (see section 3.6).

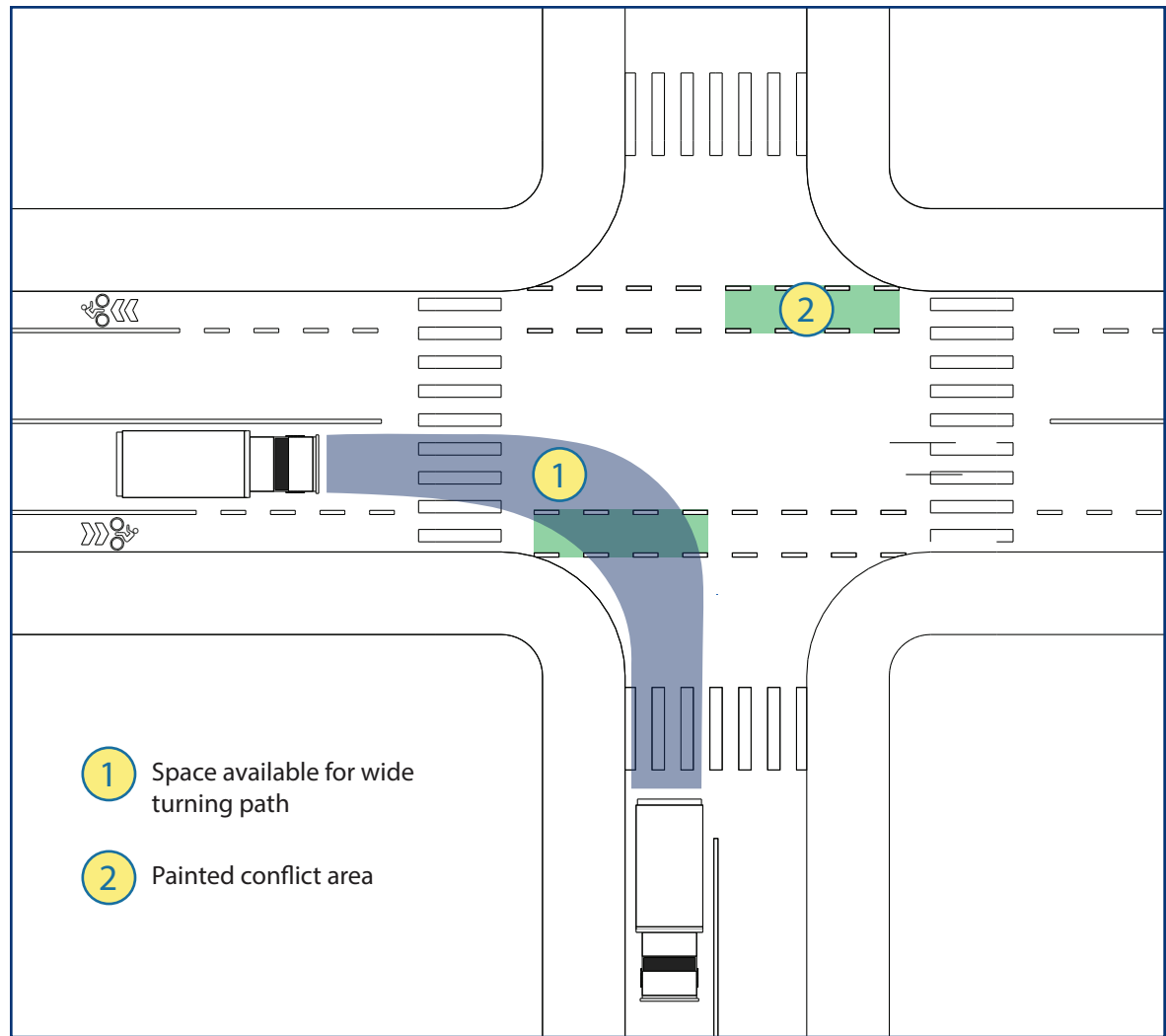

Curbside bicycle lane diagram

3.2.3 Asymmetrical Median Nose

In a location where both large vehicle turns and pedestrian crossings are frequent, a fully grade-separated median island may be desirable to maximize pedestrian safety; however, space limitations may not allow for both a standard median island and an unimpeded large vehicle turn. In these locations, an asymmetrical median can maintain total grade separation between pedestrian and motor-vehicle movements while accommodating the large vehicle turn.¹⁵ However, this design may reduce the total sheltered space available for pedestrian waiting, which can be problematic in areas with very high pedestrian volumes.

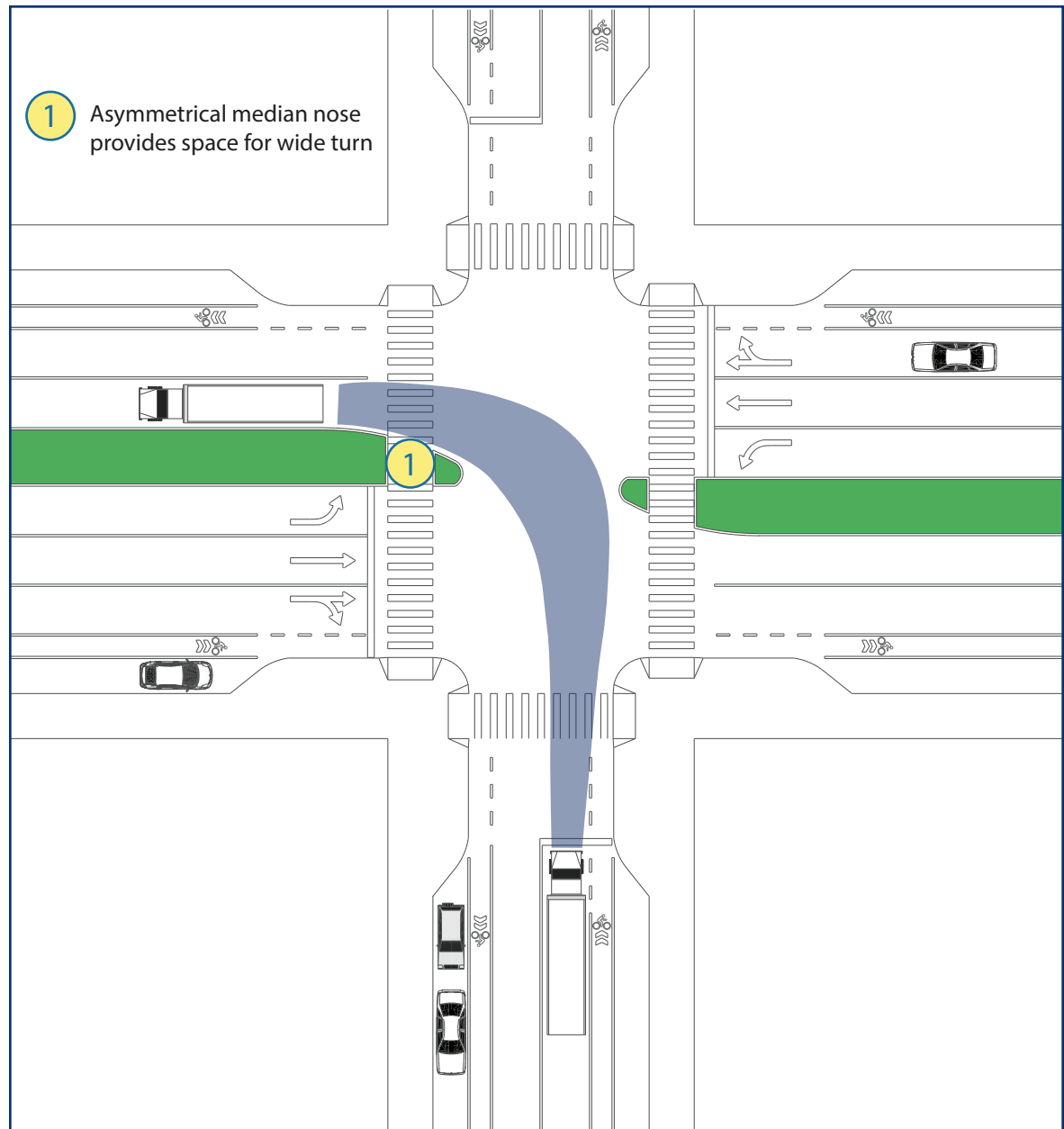

Asymmetrical median nose diagram

3.2.4 Recessed Stop Line

A stop line is a solid white transverse line that indicates the location where a vehicle should stop in advance of an intersection or crosswalk.¹⁶ A recessed stop line is a stop line set back from an intersection to provide additional space for a large vehicle to encroach into an adjacent lane to navigate a restricted turn.¹⁷ Where recessed stop lines are implemented, additional pavement markings¹⁸ or signage¹⁹ (e.g., MUTCD R10-6) may be required to clearly inform drivers where they are expected to stop, and enforcement may be necessary to ensure driver compliance. As a recessed stop line will reduce the total vehicle storage space available on a block, this solution should be implemented with consideration for the expected queuing on the recessed approach.

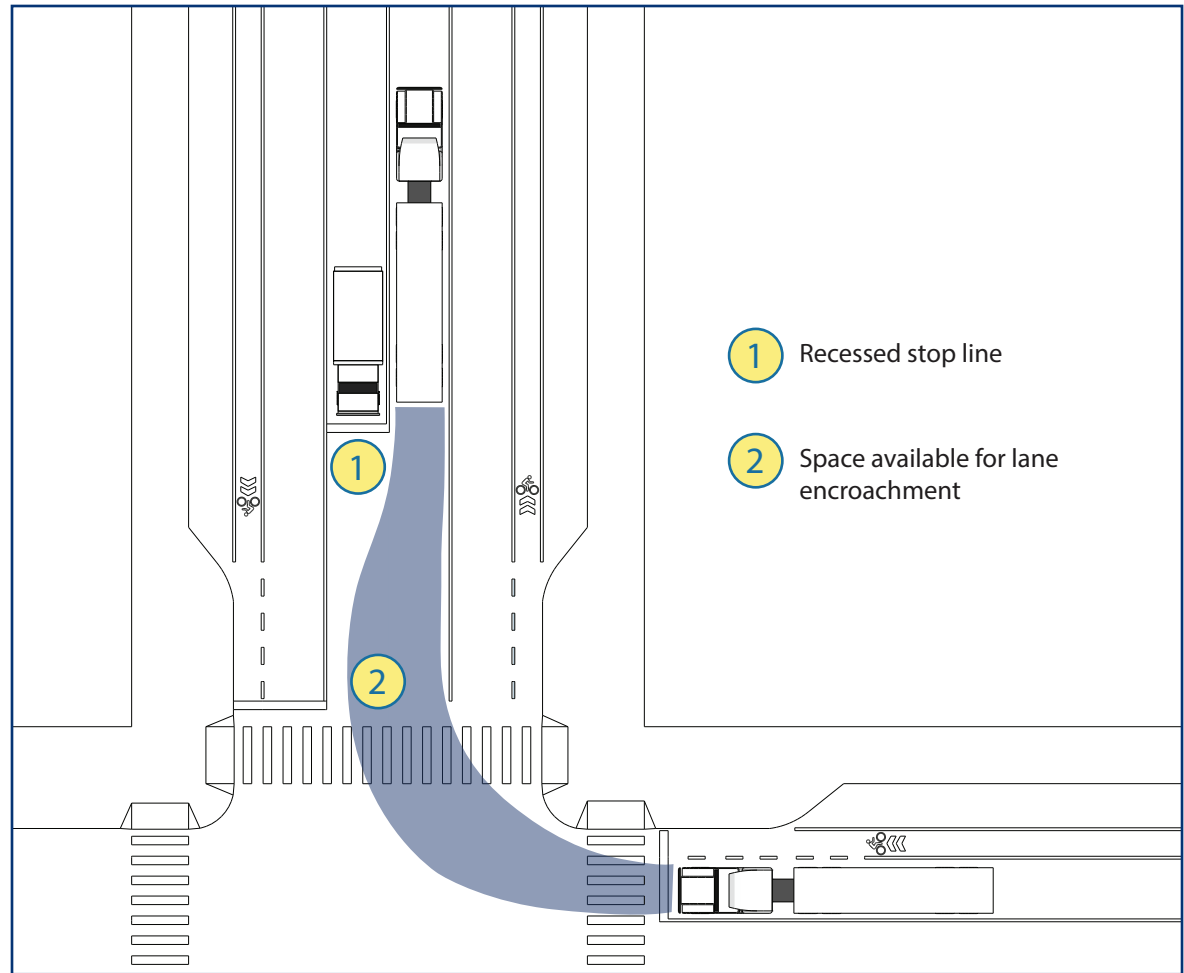

Recessed stop line diagram

3.2.5 Mountable or Flush Curbs

Unlike barrier curbs, mountable curbs are inclined so that vehicles can safely mount them at crawl speed.²⁰ Mountable curbs can allow large vehicles to encroach on raised curbs while limiting risk for vehicle or load damage or vehicle rollover. Mountable curbs can be used for a number of applications, such as:

- ◆ To provide truck aprons at corners or on median noses
- ◆ To permit encroachment onto sidewalks or medians at mid-block locations where infrequent large vehicle turns may be required (e.g., into an alley or loading dock)
- ◆ To allow a large vehicle to negotiate a chicane,²¹ roundabout,²² or traffic circle (see section 3.4.2)
- ◆ To allow emergency vehicles to cross a divided street at mid-block (see section 3.5.3)²³

Flush curbs can delineate space for different users at grade with color or texturing, and like mountable curbs, can be employed to allow occasional encroachment of a large vehicle into typically pedestrian space.

If heavy vehicle encroachment onto a raised or flush curb is permitted, the infrastructure must be strengthened to prevent damage from heavy loading.²⁴ If sidewalk space is affected,



Above: Flush curb
Right: Mountable curb detail

potential impacts on Americans with Disabilities Act (ADA) design compliance must also be considered. Flush and mountable curbs should be implemented with caution, as large vehicle encroachment into sidewalk space can present a considerable risk to pedestrians, especially if that encroachment occurs where pedestrians may be in a driver blind spot (see section 3.3).²⁵

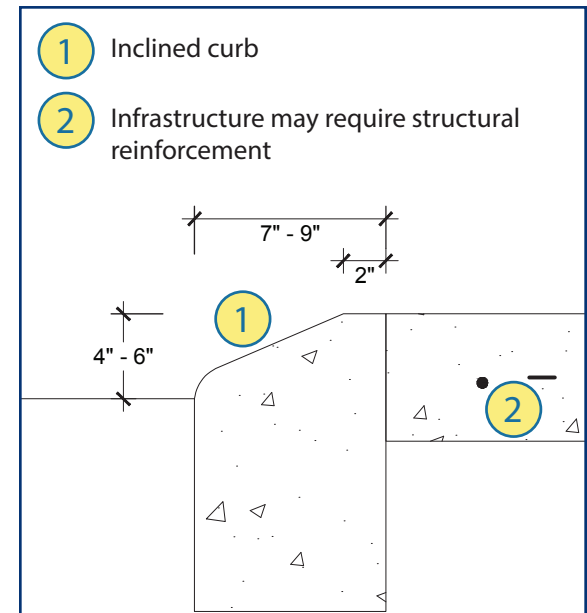

3.2.6 Painted, Striped, or Textured Curb Extensions

In areas where narrow travel lanes are desirable, but where large vehicle operations are relatively frequent or fire access is required, solid paint, striping, and pavement texturing can be used in lieu of raised curbs to visually narrow travel lanes and reduce exposure in active travel lanes. Although these solutions do not provide the same level of protection to pedestrians as raised curbs, these at-grade pavement treatments can discourage passenger car use of street space without inhibiting a larger vehicle's travel path.²⁶ These solutions can also be used in coordination with breakaway bollards, which can deter vehicles from crossing into a protected space, but will break away if that space needs to be accessed by an emergency vehicle.²⁷



Top: Striped curb extension

Bottom: Textured curb extension

3.2.7 Channelized Right Turn Lanes

Channelized right turn lanes are generally not recommended in pedestrian-friendly environments as they can encourage high-speed turns and lengthen total pedestrian crossing distances. However, they may be the best available

solution in locations with frequent large vehicle movements where other solutions may cause severe traffic problems or pose significant risk to non-motorized travelers.²⁸



Channelized right turn

3.2.8 Vehicle Size Restrictions

A frequently discussed regulatory approach to limit the space required for large vehicle movements is to simply restrict the size of vehicles operating in a city or neighborhood. For example, 53 foot semi-trailers can operate only on a few designated routes within the boundaries of New York City.²⁹ In Seattle's Downtown Traffic Control Zone, vehicles longer than 30 feet are restricted; they cannot operate during morning or afternoon peak hours, require a permit to operate during non-peak daytime hours, and can operate without a permit only at night.³⁰ Where large vehicles are banned at all times, a smaller design vehicle can be used. In areas with time-specific restrictions, conflict risk from control vehicle encroachment will be reduced. However, the safety benefits of size restrictions must be carefully weighed against the potential undesirable consequences from their implementation (see section 1.5).

3.2.9 Dedicated Signal Phases for Turning Movements

Signal phasing can also be employed to permit large vehicles turning onto a two (or more) lane approach to encroach into an adjacent lane without a conflict occurring. When both left and right turns occur during the same signal phase, or when right turns on red are permitted, turning vehicles must turn into the nearest receiving lane to avoid a potential collision with a conflicting vehicle. During a left-turn or

right-turn only phase, vehicles can use the full width of a roadway, making a wider turn into the second receiving lane.³¹ However, introducing one or more additional signal phases is likely to increase delay to all intersection users, including drivers, bicyclists, and pedestrians. Dedicated signal phases may also be difficult to implement on corridors with coordinated signal timing, as phasing must be consistent with upstream and downstream intersections.

1 Separated turn phases

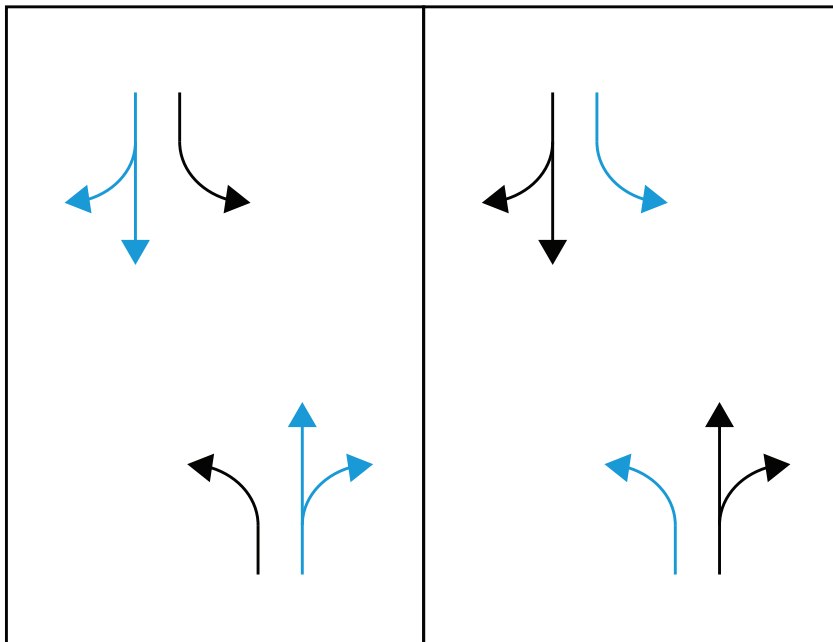

2 Separated directional movement phases

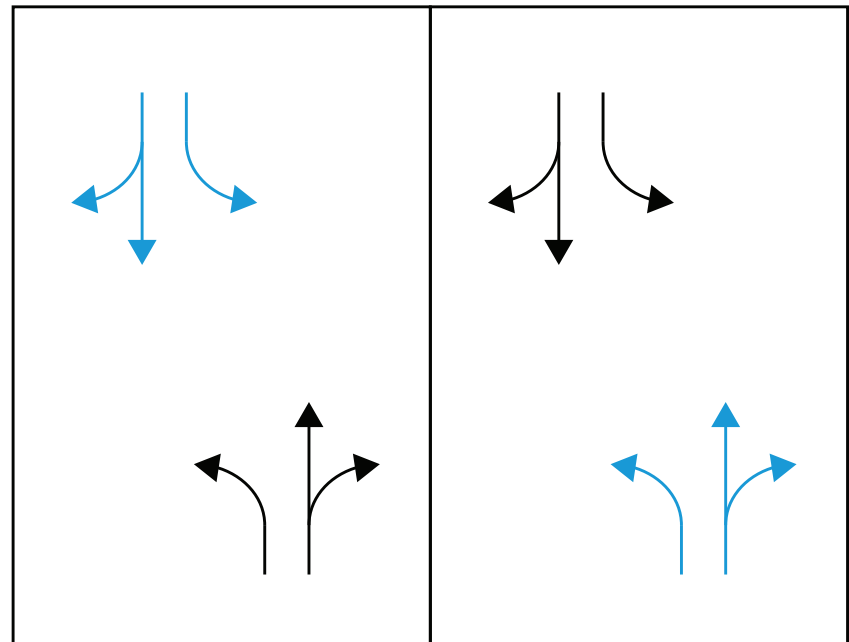

Dedicated signal phase diagrams

3.3 Reducing the Frequency and Severity of Conflicts Between Large Vehicles and Vulnerable Roadway Users

Large trucks present a safety risk for other users operating in shared space. Collisions involving a large truck and a non-motorized traveler will often result in a serious, if not fatal outcome. In many areas, large vehicles contribute to a disproportionate share of fatal collisions and collisions causing serious injury.³² In addition to the bigger size and frequently higher weight of the vehicles themselves, large truck operators often have blind spots that can prevent them from seeing bicyclists and pedestrians as well as smaller vehicles. Common blind spots on a truck operated by a left-side driver include areas immediately in front of a truck, behind a truck, to the left of a truck cab, and much of the area on the right side adjacent to and behind the truck. Front blind spots are larger on a conventional cab truck than on a cab-over-engine truck. Turning emergency vehicles can also present a safety risk, regardless of their size, if they do not adequately reduce their travel speed at an intersection while responding to an incident. In the case of emergency vehicles; however, collision risk from high-speed operations must be balanced against the potential public health and safety impacts from a delayed response time.

A variety of approaches can be implemented on mixed-use streets to manage the frequency and severity of right-hook and other conflicts between large vehicles and vulnerable roadway users. These include roadway design elements, signal phase design, curbside and on-vehicle equipment and technologies, and education programs. The following section discusses

alternatives that have been implemented internationally. Again, design solutions should be considered in the context of local agency guidelines. Solutions not currently adopted into street design standards maybe considered as pilot treatments.



Truck with conventional cab

3.3.1 Bike Boxes and Two-Phase Turn Queue Boxes

Both bike boxes and two-phase turn queue boxes provide visible space dedicated for cyclists at intersections. Bike boxes provide a designated area in front of a motor vehicle queue where through cyclists can wait during a red signal phase. Two-stage turn queue boxes provide on-street space to allow cyclists to wait to cross an intersection with an opposing traffic stream rather than to join or weave across an active motor vehicle lane. Presence of these treatments regardless of the presence of a waiting cyclist can also serve as a visible reminder to truck drivers that cyclists may be present. For detailed design guidelines for bike boxes and two-stage turn queue boxes, readers are referred to the NACTO Urban Bikeway Design Guide.³³ Please note, both bike boxes and two-phase turn queue boxes currently have interim approval from the FHWA for implementation in the U.S.³⁴



*Top: Bicycle box;
Bottom: Two-stage queue box*

3.3.2 Paint and Pavement Texturing to Delineate Conflict Areas

In addition to visibly narrowing travel lanes or intersections, paint and pavement texturing can also be used to delineate both on- and off-street conflict areas where interactions may occur between large vehicles and other users of roads and sidewalks. Solid paint, striping, or sharrows can be used to clearly mark segments of bike lanes where a turning conflict or vehicle lane encroachment may occur (see section 3.2.1).³⁵ Paint or pavement texturing can also be used to identify areas on sidewalks or medians where a large vehicle may travel during a turning movement or may park to conduct delivery activities.



Painted sidewalk at loading dock entrance

3.3.3 Dedicated or Leading Signal Phases for Non-motorized Travelers

Dedicated or leading signal phases for pedestrians and/or bicyclists can reduce the likelihood of conflicts between motorized and non-motorized travelers. Dedicated phases allow vulnerable street users to cross an intersection while vehicle movements are not permitted. Leading pedestrian phases can also allow travelers on foot to enter an intersection ahead of turning drivers, reducing the likelihood that they will be in a large vehicle operator's blind spot.³⁶

Dedicated phases may require installation of a pedestrian or bicycle signal head.³⁷ Please note, bicycle signal heads are currently under interim approval for use in the U.S. by FHWA, and current FHWA guidance does not allow for a simultaneous bike/pedestrian dedicated signal phases.³⁸ Like dedicated turning phases, dedicated bicycle and/or pedestrian phases are likely to cause added delay for all intersection users, and may be difficult to implement in areas with coordinated signal timing (see section 3.2.9).

1 Leading bicycle phase

2 Vehicle turning phase

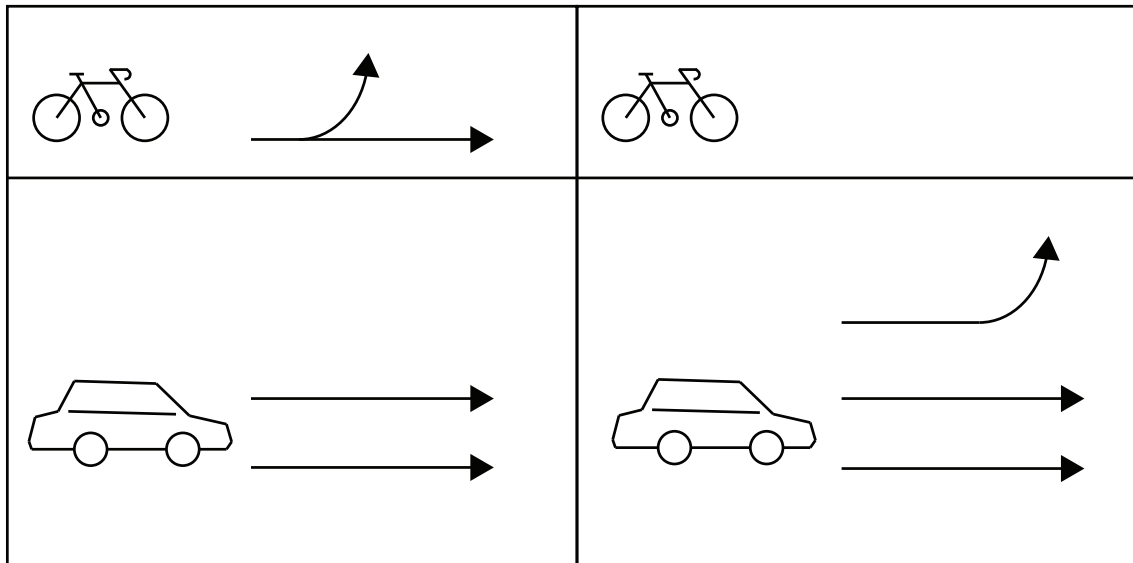

Above: Bike signal

Left: Leading bicycle phase diagram

3.3.4 Convex Safety Mirrors

Convex safety mirrors can be used to provide driver visibility of an area that would typically fall outside of the driver's line of vision. At locations where large vehicles are expected to operate at low speeds, convex safety mirrors can improve visibility of vulnerable roadway users within expected driver blind spots. As the mirror must be mounted in a fixed location, the size and height should be determined with consideration for the sight lines for drivers. Convex safety mirrors are not currently approved in the MUTCD for on-street application in the U.S. as a traffic control device, but are commonly used in off-street locations such as driveway and loading dock entrances.



Convex safety mirror mounted to lightpost

3.3.5 On-Board Blind Spot Mitigation

A variety of types of on-board mirrors, lenses, and cameras can be installed on large vehicles to reduce driver blind spots. The European Commission mandates that heavy goods vehicles are fitted with six different types of mirrors. The two types most recently mandated in 2009 specifically provide visibility of areas directly to the right side of the vehicle during a turning movement and directly in front of a vehicle when starting from a stop.³⁹ Crossover mirrors, which provide visibility in front of a vehicle, are required by New York State law on conventional cab trucks over 26,000 pounds operating in cities with populations of 1 million or more residents. These mirrors allow drivers to see into the blind spot directly in front of their vehicle.⁴⁰ Fresnel safety lenses are inexpensive plastic lenses that can be attached to a truck's passenger window to allow drivers to see into the blind spot on the right side of the vehicle.⁴¹ Side view, rear-view, and night-vision camera/video image systems provide images from externally mounted cameras to in-cab displays.⁴²

Several recent studies in the UK have also examined the direct vision of different truck configurations. Direct vision measures the driver's field of vision from a cab without use of mirrors or other technologies. In 2016, the City of London implemented the first known Direct Vision Standards (DVS) for heavy goods vehicles; these standards rate vehicles on a scale from zero to five based on how much a driver

can see directly.⁴³ Starting in 2020, the worst performing vehicle configurations will be banned from operating in London. These regulations not only ban dangerous vehicles, but also encourage manufacturers to develop vehicle designs that limit driver blind spots.



Cost Challenges

The challenge in implementing any vehicle design or equipment standard is the cost of retrofit or replacement. If standards only apply to newly manufactured vehicles, impacts will be minimal until a significant share of the local fleet turns over. If retrofit or replacement is mandatory, costs must be identified and industry impacts by operator type should be assessed (see section 1.5).

Truck-mounted crossover mirror

3.3.6 Truck Side Guards

Truck side guards reduce the open space between vehicle axles and between the pavement surface and a truck undercarriage. These devices reduce the severity of side collisions between trucks and vulnerable roadway users, as they can prevent a pedestrian or bicyclist from being pulled under the rear tires of the vehicle.⁴⁴ Side guards have been mandated in many international cities since the 1980s.⁴⁵ They were recently mandated in the city of Boston, and have been implemented on municipal fleets in New York and Seattle. For detailed discussion of truck side guards, readers are referred to the Volpe Truck Side Guards Resource Page.⁴⁶



Truck with side guards

3.3.7 Education Programs

Education programs inform both vehicle operators and vulnerable roadway users about factors that may contribute to collisions. In New York City, the Department of Transportation's Truck's Eye View program educates local residents about truck blind spots by allowing them to sit in the cab of a truck parked at community events.⁴⁷ Alternatively, in the UK, the Safe Urban Driving training offered under the Fleet Operator Recognition Scheme (FORS), a voluntary accreditation program for safe commercial vehicle operators, includes a "practical cycling module" that requires truck drivers to experience roads from a cyclist's perspective.⁴⁸ A similar module may be relevant for training professional or volunteer emergency vehicle operators. NYC DOT's *Bike Smart: The Official Guide to Cycling* in NYC includes instructions for cycling near large vehicles, and CitiBike, New York's bicycle share system, includes warnings about truck blind spots directly on the handle bars of bicycles.

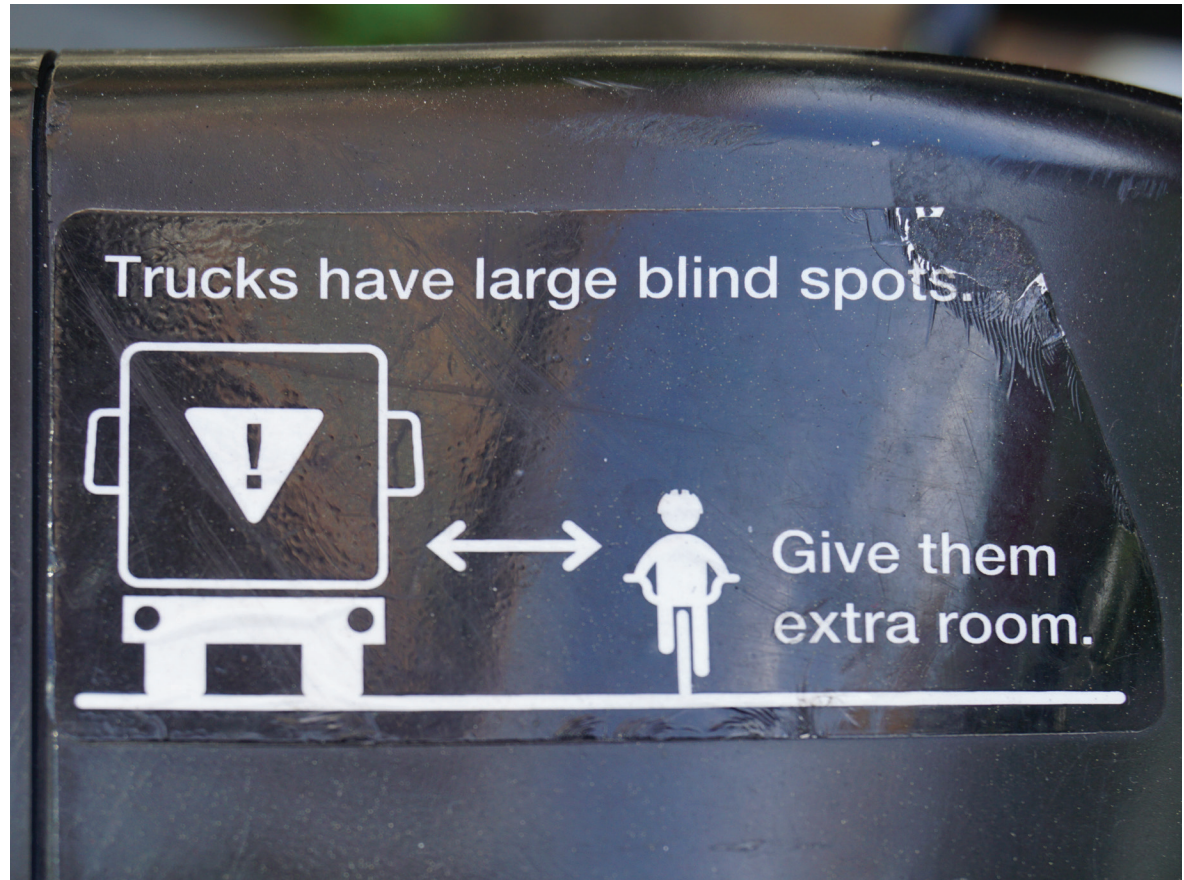

Educational sticker on CitiBike bike share handle bars

3.4 Reducing Speeds Without Unintended Detrimental Impacts on Operations and Safety

Low travel speeds are desirable in bicycle- and pedestrian friendly areas. A number of infrastructure alternatives can be implemented to reduce driver travel speeds. Types of raised speed reducers typically used on public roadways include speed humps, speed tables, and speed cushions.⁴⁹ Speed humps and speed tables both have 3-3.5 inch raised sections that usually extend the full width of a travelway; while the former is typically 12-ft long with a curved surface, the latter consists of a 10-ft long flat surface with 6-ft long graded, curved, or sinusoidal entry and exit ramps. Speed cushions are similar in length to a speed hump, with individual sections that are about 6 feet wide, and do not extend across the full travelway. Alternative mid-block speed reduction approaches include mid-block pinch points, lateral shifts and chicanes.⁵⁰ Mid-block pinch points physically narrow the travelway, while lateral shifts introduce a curved travel path on an otherwise straight section of roadway. Chicanes both narrow and introduce curvature to the travelway.

At intersections, traffic circles, mini-roundabouts, and small modern roundabouts can all slow vehicle travel speeds by requiring drivers to take a circular path through an intersection. Traffic circles are intersections with a raised circular island at the center.⁵¹ Small modern roundabouts and mini-roundabouts also have a circular center island installed at the intersection, but like larger roundabouts include splitter islands to direct traffic entering the intersection.

Many of these speed control elements can present a challenge for both freight and emergency vehicle operations. Any device that reduces travel speeds will have a detrimental impact for emergency response times, which can critically impact public health and safety outcomes. One exception may be that at traffic circles and roundabouts, these delays may be offset by the elimination of signal delay compared to signalized intersections.⁵² Raised speed reducers are designed so that a vertical deflection will cause driver discomfort in speeding vehicles; however, this deflection can be dangerous to both personnel and patients traveling in emergency vehicles, and can cause equipment damage.⁵³ While impacts will vary depending on the type of freight vehicle, suspension type, load

carried, and vehicle load factor, hitting a raised speed reducer can potentially result in equipment damage or damage to the goods being carried.⁵⁴ Noise can also be generated when vertical deflection shifts equipment and loads on large vehicles. Solutions such as chicanes that require large vehicles to travel a curved path may be difficult to navigate if adequate roadway width is not maintained. Parked or oncoming vehicles may cause additional delays to large vehicles traveling these configurations.⁵⁵ At traffic circles, small modern roundabouts, and mini-roundabouts, large vehicles may have difficulty navigating a counter-clockwise left turning movement.⁵⁶

A few alternatives exist to mitigate these challenges while also slowing driver speeds; these are discussed in the following section.

3.4.1 Speed Cushions

Speed cushions are the most appropriate type of raised speed reducers for use on emergency access and freight routes, as they do not extend the full width of the roadway. As a result, large vehicles with wide axles can travel mostly unimpeded over speed cushions without experiencing vertical deflection.⁵⁷ If fire apparatus or ambulances are expected to operate frequent on a route with speed cushions, their axle widths should be explicitly considered in determining the width and placement of the cushions.

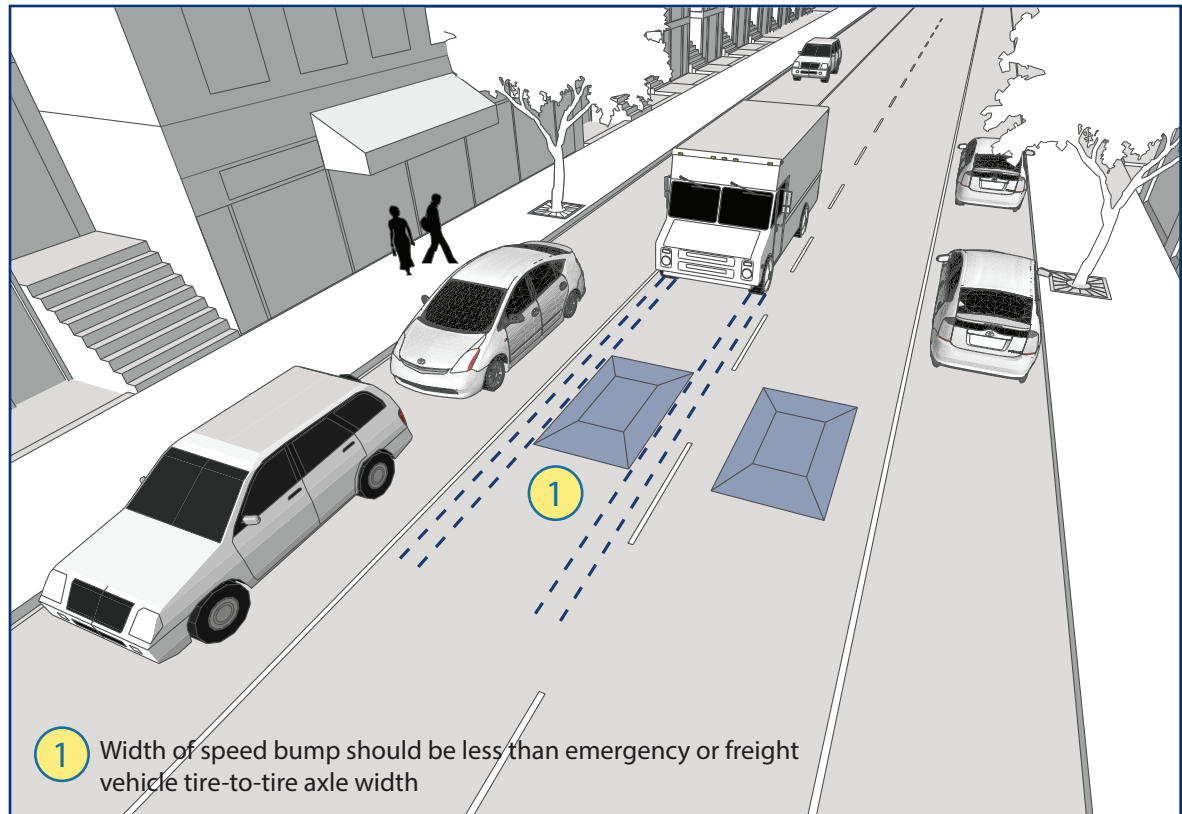

Speed cushion diagram

3.4.2 Mini Roundabouts

Mini-roundabouts are generally preferable to traffic circles and small modern roundabouts for emergency operations, as their center islands and splitter islands are mountable or flush with the roadway surface (see section 3.2.5 Mountable of Flush Curbs) rather than raised with barrier curbs. When center islands are fully traversable, emergency vehicles can travel straight through the intersection with limited impact on their speed, and large vehicles can make an unimpeded left turn.⁵⁸ While large vehicles may be permitted to turn left in front of the center island at any traffic circle or roundabout to avoid a difficult counterclockwise left turn (e.g., by State or local traffic laws that permit emergency vehicles to violate turning restrictions), this movement occurs against prevailing traffic and can result in a conflict with another vehicle.⁵⁹

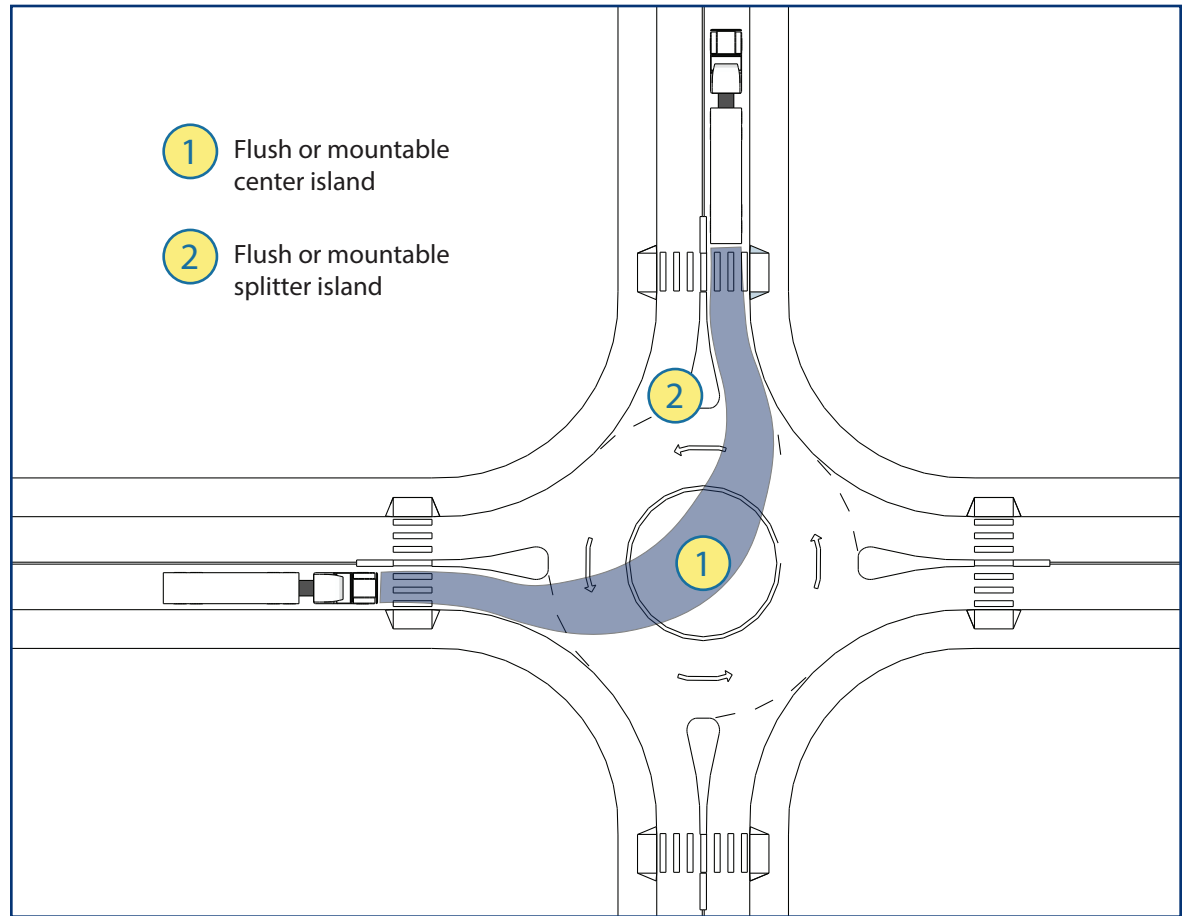

Mini-roundabout diagram

3.5 Providing Network Connectivity and Redundancy

Emergency responders rely on emergency access routes to reach incident locations. In some cities, like New York, freight vehicles are also required to operate primarily on a dedicated network of freight routes. Street design changes that restrict capacities, reduce redundancy, or restrict directional movements on these routes can impede access for emergency responders and reduce accessibility for freight operators. Some specific changes that may be problematic include:

- ◆ Conversion of a two-way street to a one-way street
- ◆ Installation of a non-traversable median
- ◆ Removal of a two-way left turn lane which may be used by emergency vehicles to bypass traffic congestion⁶⁰
- ◆ Implementation of difficult to navigate street infrastructure (see guidelines in section 3.2)

If design changes are expected to impact the navigability of a route for trucks or emergency vehicles, available alternative routes must be identified. For emergency vehicles, a significantly longer travel route will increase response times, which can affect incident outcomes. Network changes that will result in significantly longer travel distances for trucks may increase local vehicle miles traveled, which can have undesirable impacts on congestion, emissions, infrastructure damage, and collision exposure. If the time and cost increase to operate on an alternative truck route is significant, operators may choose instead to use routes not designated (or designed) for freight operations; ultimately, this can result in pavement damage, bridge hits, roadside infrastructure damage, and dangerous interactions with other roadway users. When designing street networks for freight and emergency vehicle access, the following factors should be considered.

3.5.1 Redundant Networks

Both freight and emergency vehicle operations benefit from roadway networks with a high level of street connectivity.⁶¹ Connected networks typically include relatively short blocks (or frequent intersections) and parallel alternative routes that provide redundancy. In a network with these characteristics, an emergency vehicle can bypass congestion or other roadway obstruction by rerouting to a nearby alternative path. The local fire code may explicitly mandate redundant access to buildings. According to the NYC Fire Code, “more than one fire apparatus access road” can be required “where fire apparatus access is impeded to or on the primary access road as a result of substandard width public streets, substandard width fire apparatus access roads, traffic patterns, traffic calming devices, railroad crossings, and other conditions that would significantly delay an emergency response.”⁶² For tall buildings and other large building types, the International Fire Code mandates two or more fire access lanes. Where present, and where space allows, alleys can provide a secondary means of access to individual buildings for both emergency and freight vehicles.⁶³ When designating routes for a restricted freight network, redundancies should also be explicitly considered; designs that restrict movement on a freight route without the availability of a reasonable alternative should be avoided.

3.5.2 Wide Bike Lanes

As previously discussed, emergency vehicles responding to an incident have first priority for all on-street space, including bicycle lanes. Wide bicycle lanes can help maintain access for emergency vehicles by serving two functions. On routes with one travel lane in each direction and a median, bicycle lanes that are at least six feet wide can provide space for motor vehicles to pull over and allow an emergency vehicle to pass.⁶⁴ Although extreme caution is necessary to ensure that a conflict with a cyclist or pedestrian does not occur, a curbside bicycle lane with a flush buffer may also be wide enough to be used by an emergency vehicle as a travel lane to bypass extreme congestion.



Wide bike lane installed on avenue in Manhattan

3.5.3 Mountable Medians

On a long block divided by a median, occasional mid-block crossing may be desirable to shorten emergency response times. A mountable median can be installed to allow mid-block vehicle crossing. If a mountable median is installed for emergency use only, signage may be necessary to discourage other drivers from using the crossing. Pavement color or texturing can also be used to designate the median as a primarily pedestrian space.

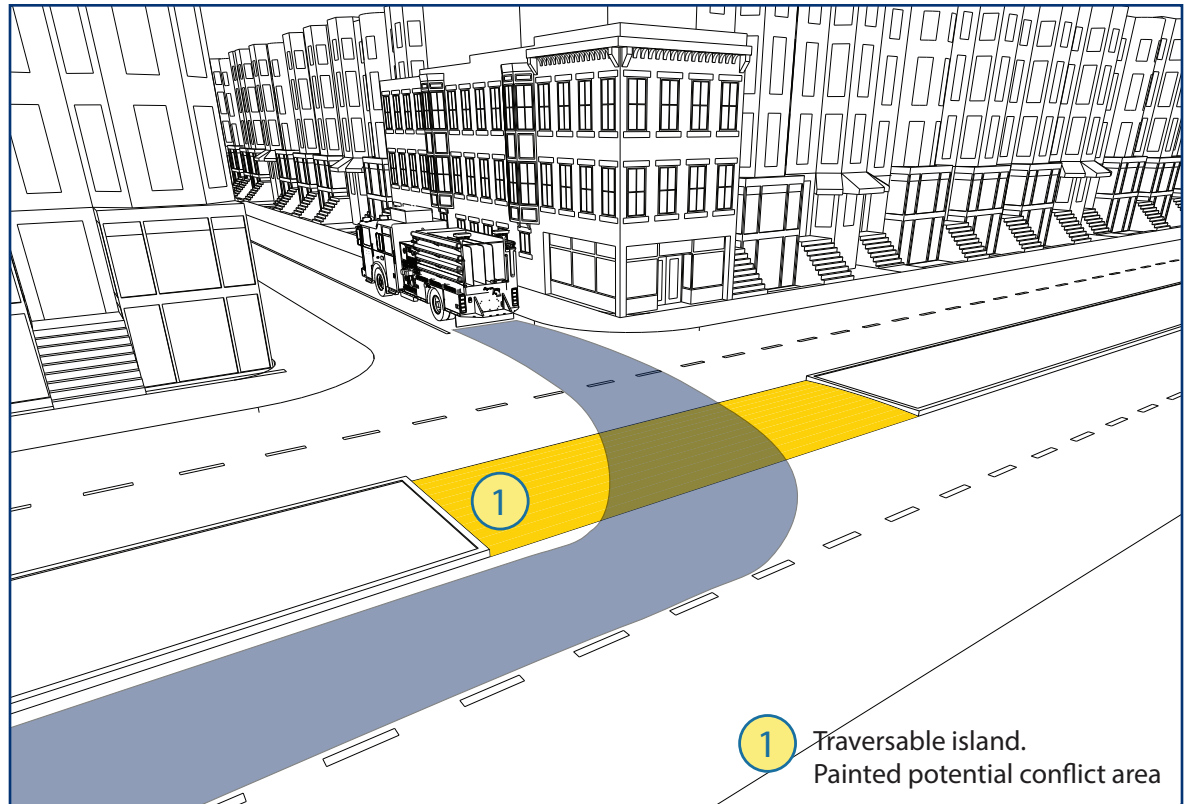

Top: Mountable median diagram

Bottom: Mountable median with brick paving



3.6 Providing Adequate Space for Vehicle Parking, Loading, and Delivery or Emergency Operations

If freight demand is expected to or from commercial or residential buildings (see section 1.1), space must be provided for loading and unloading. Freight loading/unloading activity can occur on-street or off-street in a loading dock, alley, or parking lot. Frequently on mixed-use streets, on-street parking space is limited by implementation of dedicated infrastructure for pedestrians, bicycles, or transit. Curbside bus and bicycle lanes can completely eliminate curbside parking. In locations with parking-protected bike lanes, some parking is maintained between a bicycle lane and a travel lane, but some space is also consumed by raised islands or intersection mixing zones.⁶⁵ In livable communities, many alleys are also being repurposed for “green” uses.⁶⁶

Space is required not only to allow large vehicles to park, but also to allow for vehicle loading/off-loading, sorting, and vehicle navigation into and out of a loading space. Additional space may be required for loading and handling equipment such as ramps and lift gates. If no on- or off-street space is available for commercial vehicle parking, trucks will frequently double

park to conduct necessary delivery activity. Double parked vehicles can obstruct travel or bicycle lanes, resulting in congestion, related emissions impacts, and dangerous conflicts between bicyclists and motor vehicles. Delivery persons offloading goods from a double-parked, side-loading vehicle may also be at risk of conflict with vehicles in adjacent travel lane. Sidewalks, crosswalks, bicycle lanes, and vehicle lanes can be obstructed if on-street loading zones or off-street loading docks are not long enough to accommodate a delivery vehicle (see section 1.3). If space for sorting and loading is inadequate, goods may also be piled in bicycle or travel lanes or may obstruct the sidewalk.

Fire apparatus typically require more operating space than other types of emergency vehicles. In addition to mandating the road widths required for fire apparatus operations, local fire codes may provide specifications regarding the frontage space required for event staging (see section 2.4).

The following section discusses alternatives to ensure adequate space for parking, loading, and delivery or emergency operations.



Clockwise from top left: Lift gate; Ramp; Loading in travel lane; and Obstructed sidewalk loading

3.6.1 Dedicated On-street Space

Dedicated on-street loading zones provide designated space for freight loading and unloading activities. On-street loading zones require adequate space for a design vehicle to park, to maneuver into and out of the space, and to safely conduct loading and unloading activities. For maneuvering, Transport for London recommends at least 1.5 times the width of a design vehicle of added space in front of the vehicle and the width of the vehicle of added space behind it.⁶⁷ Washington DC's Downtown Curb Space Management Plan increased the length of many on-street loading zones to 100 ft. On streets with parking-protected bike lanes, FHWA recommends considering a five-foot minimum access aisle between a loading zone and a bike lane (see section 3.7.1 Mid-block Curb Cuts). In locations where double parking in a travel lane for delivery is both legal and frequent, travel lane widths should provide adequate space for a driver to safely exit a vehicle and load or off-load goods.

The placement of dedicated space can also affect its use. Vehicles moving very heavy goods—such as furniture—are unlikely to park at a long distance from a delivery location. Drivers making very short delivery stops will be unlikely to spend extra time searching for parking or maneuvering into and out of a curbside space, especially where legal double parking is permitted or where parking regulations are of limited effectiveness (see section 1.5). To increase curbside parking in Washington, D.C., curbside loading zones were moved to approach block-ends to ease maneuvering into and out of the space.⁶⁸

For fire department operations on blocks with tall buildings, ITE recommends considering mid-block no-parking zones no longer than 50 feet.⁶⁹ Clearance must also be provided at any fire hydrant locations.



Dedicated on-street loading zone signage



3.6.2 Offset Bus and Bicycle Lanes

Offset bus and bicycle lanes maintain space for direct loading at the curb, can provide additional space to allow a vehicle parked at an off-street loading dock to overhang a curb without obstructing an active travel lane, and can provide larger turning radii at intersections (see section 3.2.1 Curbside Parking Lanes). In an offset bus lane, online bus loading access can be maintained with transit bulbs. Especially in areas where frequent illegal parking is expected to obstruct emergency vehicle clearance at the curbside, fire hydrants can also be located on curb extensions to maintain access directly from

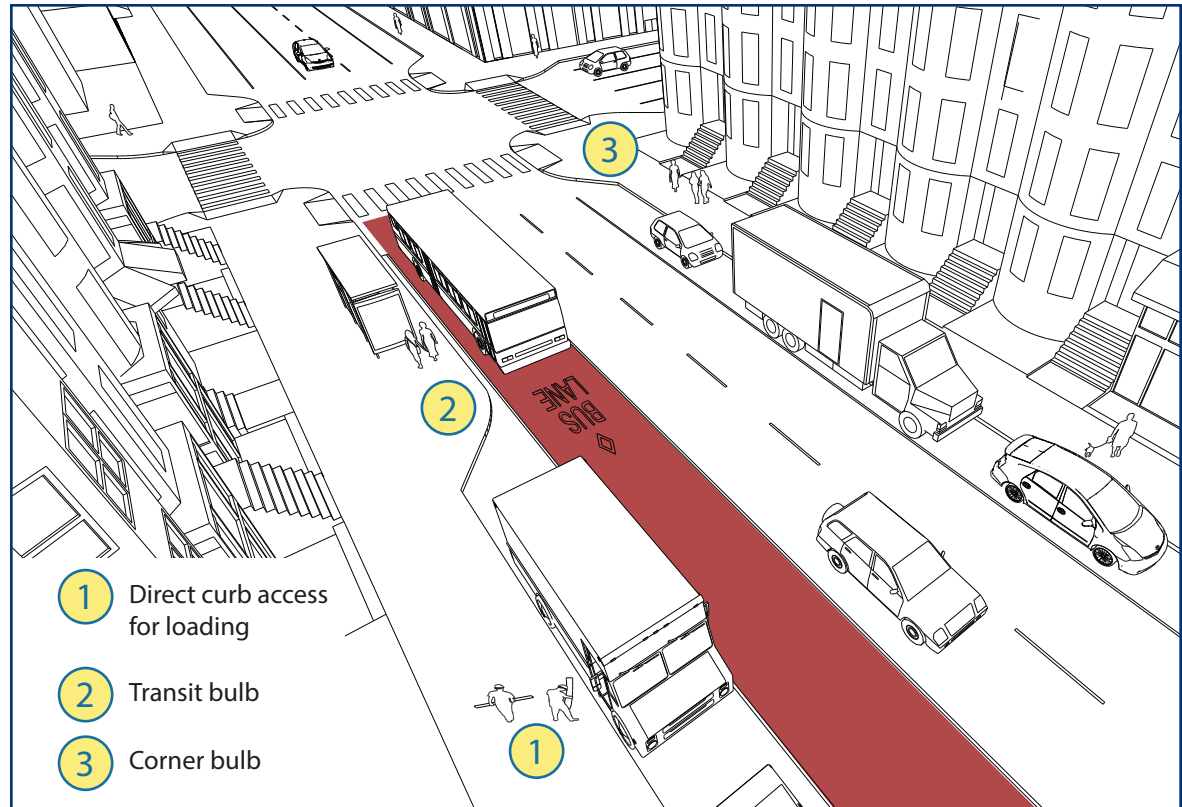

Left: Offset bicycle lane

Above: Offset bus lane diagram

a travel lane.⁷⁰ Despite these benefits, offset bicycle lanes immediately adjacent to parked vehicles can be problematic for cyclists, who will be at risk of dooring.

3.6.3 Mountable Sidewalk or Sidewalk Cutouts

In a location where a curbside travel lane prevents curbside parking and where excess sidewalk space is available, some sidewalk space can be repurposed for freight vehicle parking. In Paris, full- and half “Lincoln curbs” have been implemented in locations where on-street curb space is unavailable.⁷¹ A mountable curb allows freight vehicles to fully or partially park on a painted or textured section of sidewalk. As with all applications of mountable curbs (see section 3.2.5), this design can present a risk to pedestrians if a conflict area is not clearly identified, sidewalks may need to be strengthened to prevent damage from heavy vehicle loading,⁷² and in US applications, ADA compliance must be considered.⁷³

In cities such as Paris⁷⁴ and Oslo,⁷⁵ curb cutouts have also been implemented to allow freight vehicles to use space that might typically be designated as a sidewalk area. Unlike mountable curbs, curb cutouts provide full grade separation, reducing the risk of a conflict with a pedestrian. These same solutions can be employed to provide fire vehicle access where the distance between a building and the nearest travel lane is too long. However, vehicles parked on the sidewalk at-grade with pedestrians will reduce sidewalk capacity while loading vehicles are present, and curb cutouts will reduce sidewalk capacity at all times.

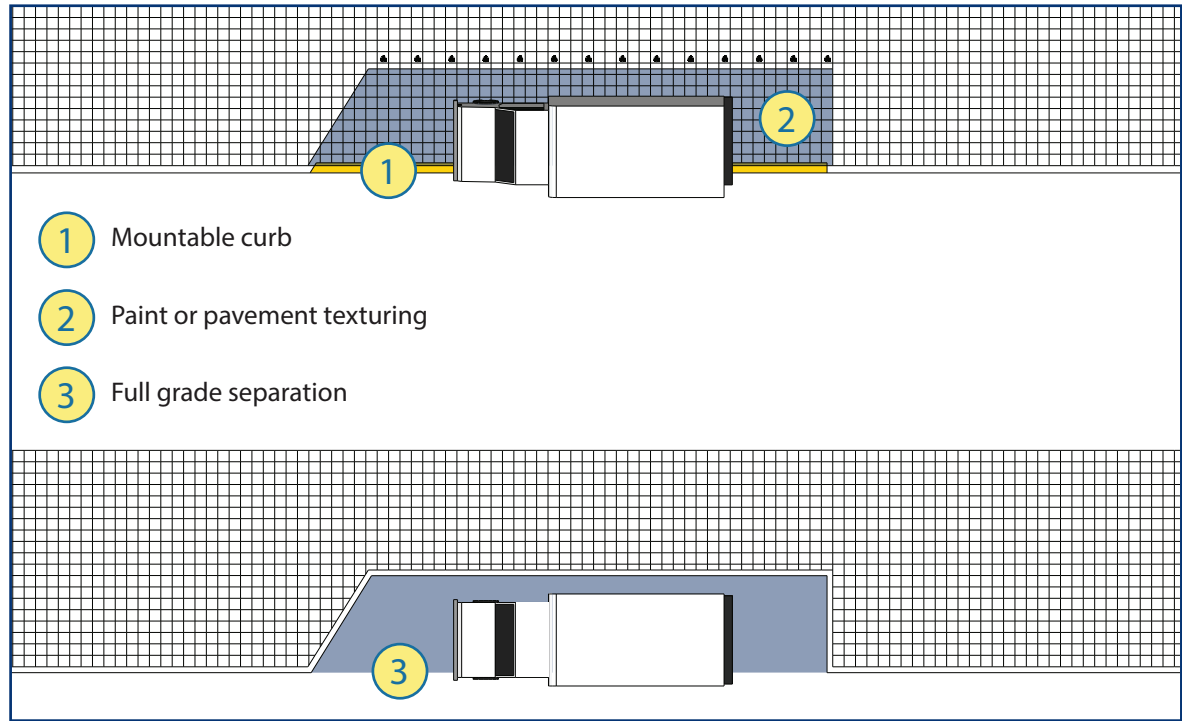

Above: Mountable sidewalk diagram

Right: Sidewalk curb cutout, “Lincoln curb” in Paris



3.6.4 Zoning Regulations

As discussed in section 1.5, minimum off-street parking and loading dock requirements are often defined in local zoning ordinances. In many cities, like New York, these loading requirements have not been updated to reflect growth in total freight traffic⁷⁶ or changes in supply chain organization. While current New York City zoning regulations mandate off-street loading space for commercial land uses, high-density residential developments that now generate thousands of package deliveries per week are not required to provide off-street loading space. In areas where new development is expected, updating these minimum requirements can ensure provision of off-street loading space.

Zoning ordinances can also define mandates for building elevators. In buildings where separate elevators are provided for freight activity, off-vehicle delivery time can be reduced by eliminating excess waiting time and extra elevator stops for passenger activity. These shorter delivery times can translate into reduced parking times, enabling more efficient use of both loading docks and curbside parking spaces.

3.6.5 Building Delivery Management

Local businesses and building managers can play a role in ensuring effective use of on- and off-street parking and loading spaces. Just as freight elevators can reduce off-vehicle delivery times, so too can good delivery management practices. In large buildings, centralized delivery locations—frequently located on a low floor—can be provided to reduce time spent by delivery persons navigating the building.⁷⁷ Even in residential buildings, shared, controlled-access package storage spaces and computerized management systems can be implemented. In areas where loading dock space is limited, scheduling systems can allow receivers to schedule deliveries to optimize usage. Many large buildings require carriers to arrive during pre-arranged time windows to complete deliveries.

3.6.6 Commercial Meter Pricing

Curb pricing can be implemented to encourage shorter delivery times and promote vehicle turnover in curbside commercial vehicle parking spaces. New York City has implemented paid commercial parking in much of midtown Manhattan. Parking rates in three-hour limited spaces increase from \$4 for the first hour, to \$5 for the second hour, and to \$6 for the third hour. A 2000 pilot study found a reduction of average parking duration from 160 minutes to 45 minutes following implementation. Although expected to be opposed by commercial operators, the program found acceptance as added parking costs were offset by savings from improved access.⁷⁸ Washington, DC also recently began charging for access to commercial loading zones; trucks are required to purchase an annual or daily permit, or to pay a per-hour fee.⁷⁹

3.6.7 Flexible Curb Regulations

Variable curb regulations can be implemented to provide commercial loading space during certain times of day, while prioritizing other uses at other times. For example, in many locations, curbside lanes provide additional vehicle lane capacity during peak-hours, but permit parking or commercial loading activity during non-peak daytime or night-time areas. NYC DOT has tested delivery windows, which designate curbside space for commercial vehicle loading and unloading only during fixed time windows.⁸⁰ Where receiver constraints allow (see section 4.1), it may be possible allow to late-night or early morning freight deliveries to be conducted in space allocated for bicycle or pedestrian use at times when non-motorized traveler volumes are expected to be very low. If time-specific regulations are implemented, direct observation or carrier and receiver outreach should be conducted to ensure that proposed loading zone times are feasible to accommodate local delivery activity, as required delivery times may vary with the nature of the freight being carried (see section 1.1).

3.6.8 Enforcement

As discussed in section 1.5, enforcement is critical for two purposes: to maintain access to space dedicated for freight and emergency vehicle activity and to enforce consequences for freight operator non-compliance with regulations. Dedicating curbside space for delivery activity is only effective if that space is not occupied by another street user. Enforcement may be required to limit illegal parking by passenger or other vehicles in delivery spaces. In cities where space is signed for “Commercial” use, service vehicles may occupy space—legally or illegally—for long durations. At loading dock and driveway entrances, parking enforcement on adjacent or even opposite curbs may be required to maintain clear turning paths.

Street and curb regulations that prohibit illegal or double parking by freight operators and time and pricing restrictions that limit parking times

and durations can only be effective if there are costs consequences for non-compliance, and if these cost consequences outweigh the benefits of illegal parking behavior. Due to industry constraints and high values of time in the freight industry, it may be difficult to price fines to effectively influence driver behavior. For example, if the value of time and added fuel costs for a driver to circle and search for a legal parking space outweighs the expected fine from illegally parking to make the same delivery, the driver is likely to choose the latter. Similarly, if a receiver requires that a delivery arrive at a specific time when no legal space is provided for freight vehicles, the carrier’s options are to park illegally to complete the delivery or to potentially lose the customer, with the former as the more likely choice. In these cases, market interventions—whether incentives (see section 4.1) or higher penalties—may be required change the receiver or carrier’s behavior.



Enforcement of curb regulations is critical

3.7 Providing Safe Access to Sidewalks, Buildings, and Fire Hydrants

Once a driver exits a truck, he or she becomes a pedestrian. Operators must have a safe area to load and unload as well as a path to safely travel from a loading area to a building destination. When parking and loading do not occur directly at the curbside, operators are often required to cross or even to walk in active vehicle or bicycle lanes, where they are at risk for a collision. The walking distance from the vehicle loading area to any building to which drivers or on-board staff will be expected to make deliveries should be considered.

Similarly, emergency vehicle operators must be able to access an incident location. Local fire codes mandate specifications for safe access roads, and for some operations, specific distances between an access road and a building. For example, the International Fire Code requires that at least one access road be located between 15 and 30 feet from a tall building where fire fighters will require an aerial ladder or platform apparatus.

Low hanging trees, curbside signage, and lighting can all obstruct freight and emergency vehicle operations at the curbside. At tall building locations where aerial ladders or platforms may be used, power and other utility lines can also provide an overhead obstruction

during fire response. Bikeshare stations, bicycle parking, benches, planters, trees, parking meters, closely spaced security bollards, or other objects placed on a sidewalk can obstruct delivery operations, including loading activity or travel paths between vehicles and buildings. When streets are repurposed as pedestrian-only zones or alleys are repurposed for “green” use, alternative parking locations and delivery paths

that may be used during restricted hours must be identified; particularly if movement of heavy goods is expected, walking distances need to be minimized.

The following roadway elements should be considered to provide safe curb and building access for freight and emergency vehicle operators.



Uncoordinated placement of sidewalk furniture can impede delivery operations

3.7.1 Mid-block Curb Cuts

Mid-block curb cuts can allow delivery persons to access a curb at non-intersection locations. Direct curb access can shorten the total delivery distance, and prevent risky walking in a vehicle travel lane or bicycle lane. If an operator is required to cross an active bicycle lane to reach a mid-block curb cut, a crosswalk should be clearly delineated to warn cyclists of a potential crossing. Drivers can also carry portable signage to warn cyclists of ongoing delivery activity. A distinctive design (e.g., color, texture) may be used to distinguish curb cuts for this purpose from curb cuts for mobility impaired users; compliance with ADA requirements and potential misuse by visually impaired users should be explicitly considered in any implementation.⁸¹

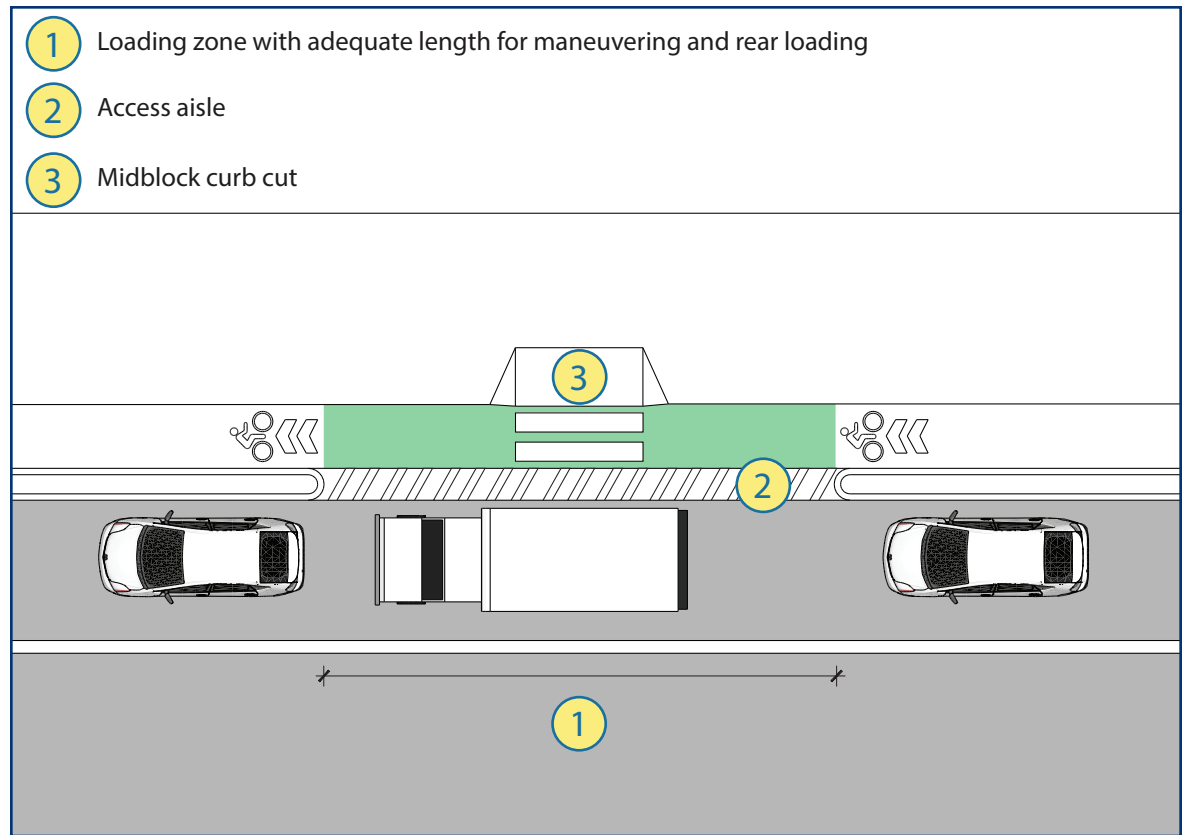

Loading zone with curb cut diagram

3.7.2 Vertical Clearance Zone

Roadway and roadside vertical obstructions must allow clearance for the tallest vehicle expected to legally operate. AASHTO defines a design vehicle height of 13.5 feet for most typical freight vehicles.⁸² Fire apparatus usually range in height from 10 to 13 feet.⁸³ Vertical obstructions such as trees or powerlines should also be avoided in any location where an aerial fire apparatus, which may extend up to 100 feet, could be used.

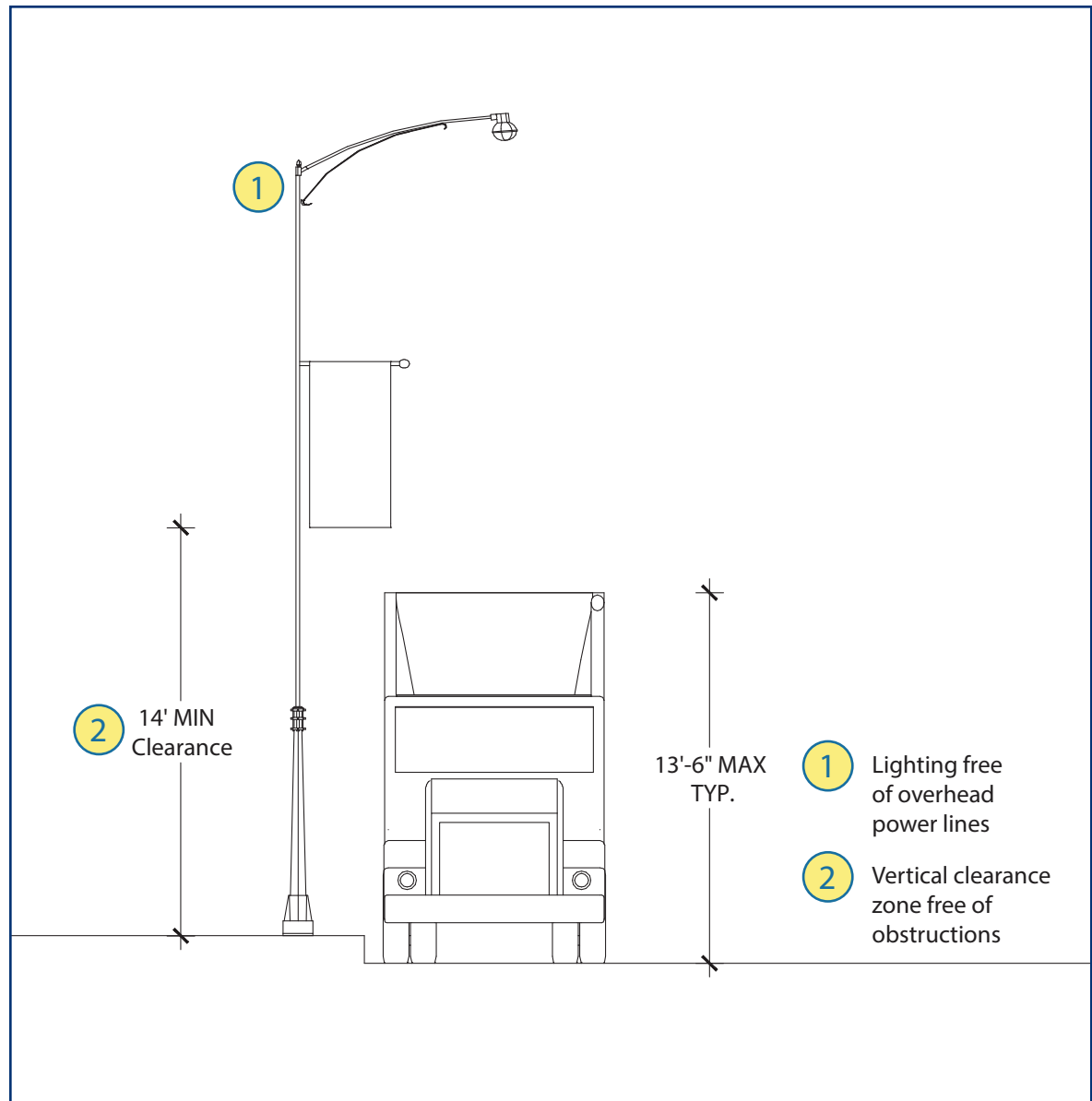

3.7.3 Horizontal Clearance Zone

When a side-loading vehicle is parked at the curbside, goods are typically loaded directly onto the sidewalk. A reasonable distance should be maintained between the parked vehicle and any sidewalk obstruction to allow an operator to off-load goods without interference. Even when a truck is not expected to offload goods directly onto a curb, the driver will need a clear path to travel as a pedestrian. In addition to providing adequate on-street space for loading activity and equipment (see section 3.6.1 Dedicated On-street Space), clearances should be provided between intersection or sidewalk obstructions along an expected pedestrian delivery path to allow typical dollies, hand carts, pallet jacks, and other equipment that an operator may use to move goods to pass unimpeded. Frontage space should be provided as needed for staging of emergency operations (see section 2.3). Local fire codes may also mandate a clear zone around a fire hydrant; for example, in New York City, a three-foot radius must be maintained.⁸⁴

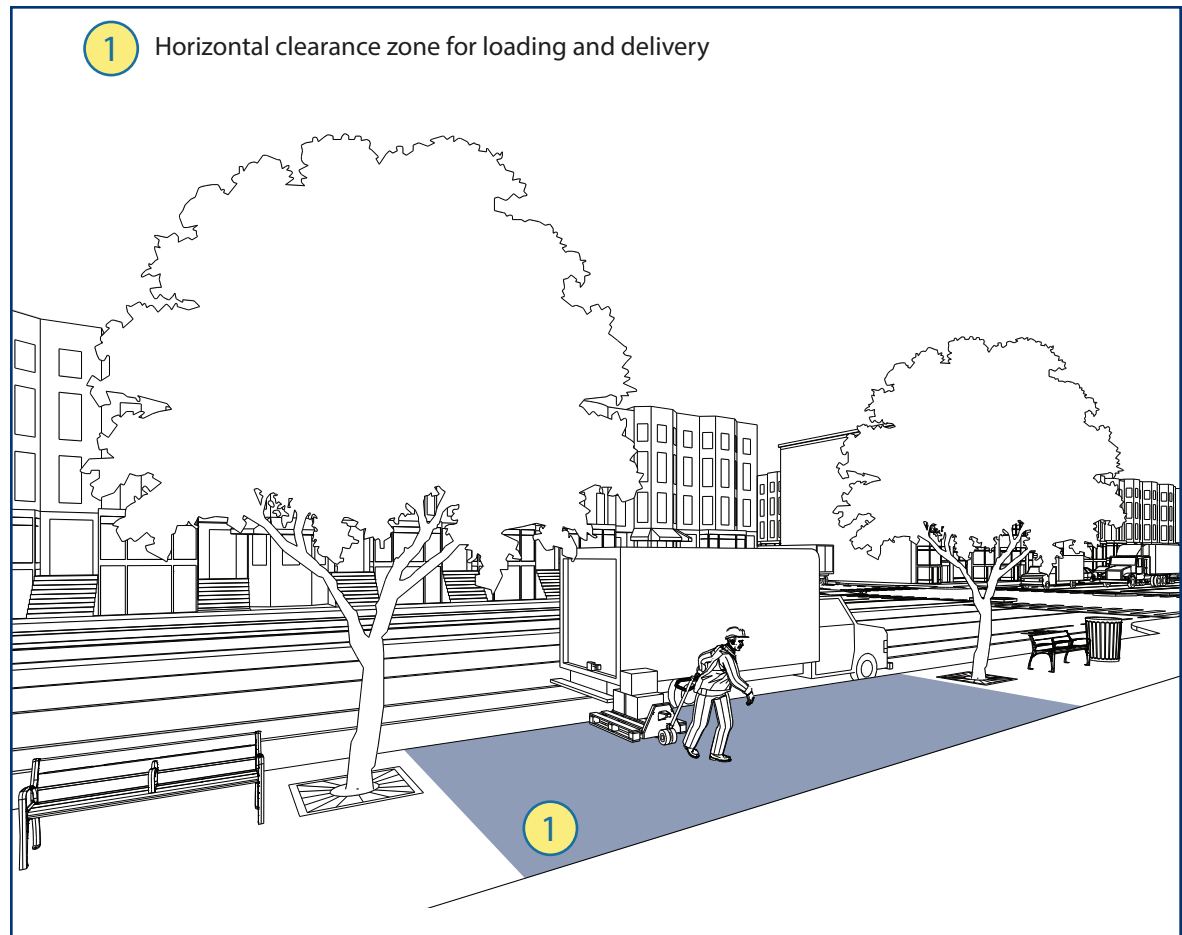

Horizontal clearance zone diagram

3.7.4 Commercial Shared Streets

Shared streets are pedestrian-friendly environments that permit shared, low speed usage of the same space between pedestrians, bicyclists, and motorized vehicles.⁸⁵ On shared streets, textured pavement surfaces and street furniture are used to delineate areas where specific activities should be prioritized. Commercial shared streets permit commercial vehicles—usually single unit trucks or vans—to conduct deliveries during all or designated hours of the day. For detailed discussion of commercial shared streets, readers are referred to the NACTO Urban Street Design Guide.⁸⁶ As discussed in section 3.6.7 (Flexible Curb Regulations), if delivery operations on a shared street are limited to restricted hours of the day, the feasibility of these hours to meet the delivery needs of business and residents located in the area should be evaluated. Alternative delivery schemes utilizing pedestrian-friendly delivery vehicles may also be appropriate on a shared street or other pedestrian zone (see Section 4.2).

Loading zone on a shared street diagram

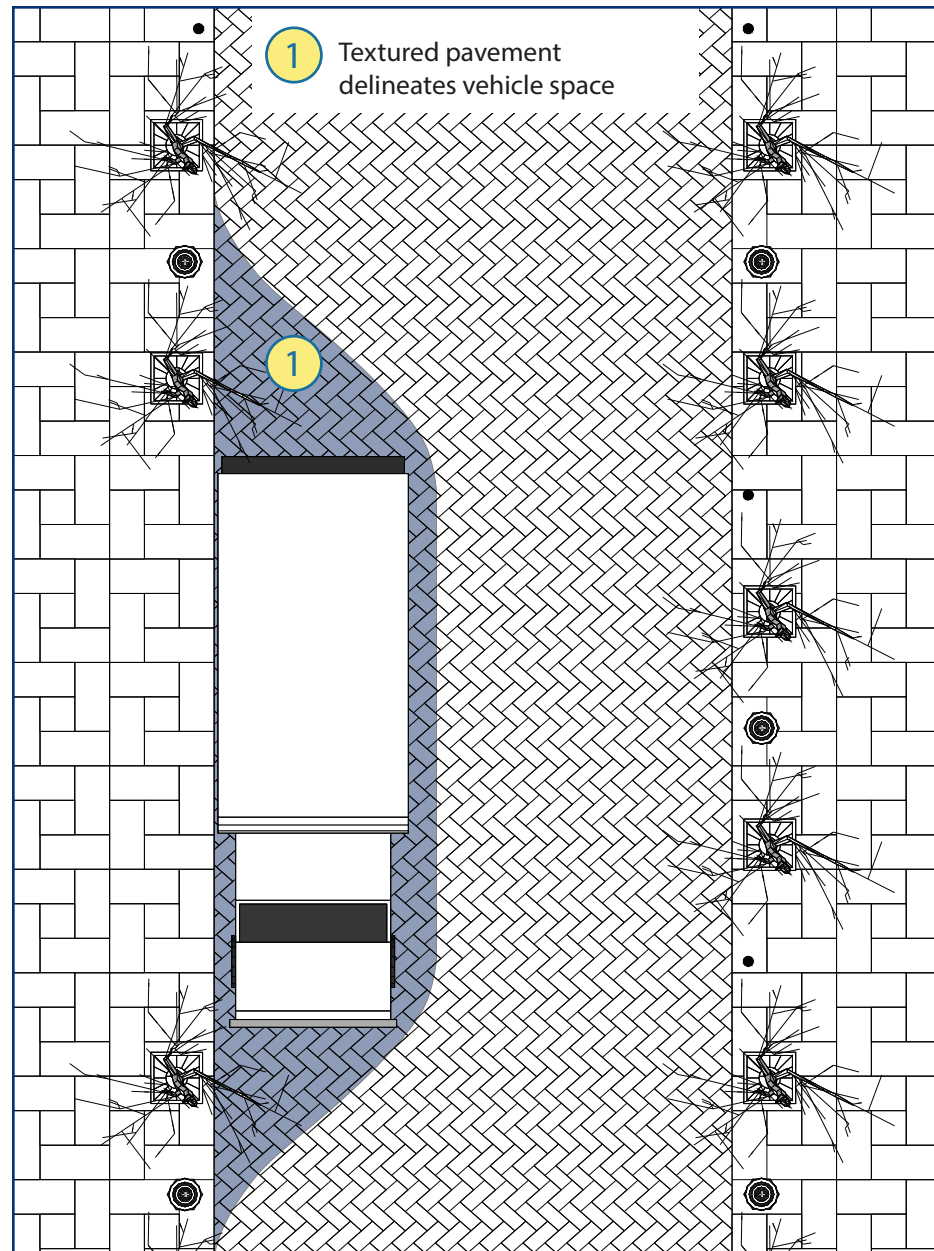

Endnotes

- 1** AASHTO (2011). *A Policy on Geometric Design of Highways and Streets*. American Association of State Highway and Transportation Officials, Washington, DC. p. 2-1.
- 2** NACTO (2017a). *NACTO Urban Street Design Guide*. National Association of City Transportation Officials, New York, NY. Accessed from: <http://nacto.org/publication/urban-street-design-guide/>. August 15, 2017.
- 3** NACTO (2017a), "Design Vehicle." Accessed from: <https://nacto.org/publication/urban-street-design-guide/design-controls/design-vehicle/>. FHWA (2016a). *Achieving Multimodal Networks: Applying Design Flexibility and Reducing Conflicts*. Federal Highway Administration, US Department of Transportation, Washington, DC. p. 17. Accessed from: https://www.fhwa.dot.gov/environment/bicycle_pedestrian/publications/multimodal_networks/fhwahep16055.pdf. August 15, 2017.
- 4** AASHTO (2011), p. 2-5.
- 5** NACTO (2017a), "Design Vehicle." Accessed from: <https://nacto.org/publication/urban-street-design-guide/design-controls/design-vehicle/>.
- 6** Portland Office of Transportation (2008). *Designing for Truck Movements and Other Large Vehicles in Portland*. Office of Transportation, City of Portland, Portland, OR. p. 11. Accessed from: <https://www.portlandoregon.gov/transportation/article/357099>. August 15, 2017.
- 7** Amherst Planning Board (2013). "The Retreat Prelim Subdiv Fire Dept Apparatus Dimensions." Town of Amherst Website, Planning Board, Town of Amherst, Amherst, MA. Accessed from: <https://www.amherstma.gov/documentcenter/view/24390>. August 15, 2017.
- 8** Portland Office of Transportation (2008), Appendix D.
- 9** Renaissance Planning (2015). *Freight Roadway Design Considerations*. Prepared for the Florida Department of Transportation District 7 Office of Intermodal Systems Development, Tampa, FL, p. 2.12 – 2.13.
- 10** NACTO (2017a), "Curb Extensions." Accessed from: <https://nacto.org/publication/urban-street-design-guide/street-design-elements/curb-extensions/>.
- 11** Snyder, R., Siegman, P., Huff, H., and McCormick, C. (2013). *Best Practices: Emergency Access in Healthy Streets*. Los Angeles County Department of Public Health, Los Angeles, CA. p. 19. Accessed from: <https://www.cnu.org/sites/default/files/Best-Practices-Emergency-Access-in-Healthy-Streets.pdf>. August 15, 2017.
- 12** ibid
- 13** FHWA (2017a). "Module 5 – Effects of Traffic Calming Measures on Non-Personal Passenger Vehicles." *Traffic Calmer ePrimer*. Federal Highway Administration, US Department of Transportation, Washington, DC. Accessed from: https://safety.fhwa.dot.gov/speedmgt/traffic_calm.cfm. August 15, 2017.
- 14** NACTO (2017a), "Bus Bulbs." Accessed from: <https://nacto.org/publication/urban-street-design-guide/street-design-elements/curb-extensions/bus-bulbs/>.
- 15** Renaissance Planning (2015), p. 3.20.
- 16** FHWA (2009a). *Manual on Uniform Traffic Control Devices for Streets and Highways*. Federal Highway Administration, US Department of Transportation, Washington, DC. p. 381.
- 17** FHWA (2016a), p. 18-19; NACTO (2017b). "Recessed Stop Line." *NACTO Transit Street Design Guide*. National Association of City Transportation Officials, New York, NY. Accessed from: <https://nacto.org/publication/transit-street-design-guide/intersections/transit-route-turns/recessed-stop-line/>. August 15, 2017.
- 18** FHWA (2009a), p. 387.
- 19** FHWA (2009a), p. 48.
- 20** NYS DOT (2004). *Highway Design Manual*. New York State Department of Transportation, Albany, NY. p. 3-48. Accessed from: https://www.dot.ny.gov/divisions/engineering/design/dqab/hdm/hdm-repository/chapt_03.pdf. Accessed August 15, 2017.
- 21** Marek, J. and Walgren, S. *Mid-Block Speed Control: Chicanes and Speed Humps*. Conference Proceedings, 68th Annual Meeting of the Institute of Transportation Engineers, Toronto, Canada, August 9-12, 1998. p. 10.
- 22** Gingrich, Mm, Lenters, M., and Waddell, E. (2009). *Trucks in Roundabouts: Pitfalls in Design and Operations*. ITE Journal, Feb. 2009.
- 23** ITE (2010). *Design Walkable Urban Thoroughfares: A Context Sensitive Approach*. Institute of Transportation Engineers, Washington, DC. p. 134.
- 24** TFL (2017a). *Kerbside Loading Guidance*, 2nd Edition. Transport for London, London, UK. p. 38. Accessed from: <http://content.tfl.gov.uk/kerbside-loading-guidance.pdf>. August 15, 2017.
- 25** Portland Office of Transportation (2008), p. 32.
- 26** City of Minneapolis (2017). "City of Minneapolis Projects & Planning Initiatives – Painted Curb Extensions." City Of Minneapolis, Minneapolis, MN. Accessed from: <http://www.minneapolismn.gov/pedestrian/projects/WCMS1P-151213>. August 15, 2017.
- 27** City of Dallas (2016). *Dallas Complete Streets Design Manual*. City of Dallas, Dallas, TX. p. 21. Accessed from: http://dallascityhall.com/departments/pnv/DCH%20Documents/DCS_ADOPTED_Jan272016.pdf. August 15, 2017.
- 28** FHWA (2016a), p. 19.
- 29** NYC DOT (2017). "Size and Weight Restrictions." NYC DOT Website, Department of Transportation, City of New York, NY. Accessed from: <http://www.nyc.gov/html/dot/html/motorist/sizewt.shtml>. August 15, 2017.
- 30** Seattle DOT (2016). "Downtown Traffic Control Zone Map." Seattle Department of Transportation Website, City of Seattle, Seattle, WA. Accessed from: <https://www.seattle.gov/transportation/dtczmap.htm>. August 15, 2017.
- 31** NACTO (2017a), "Corner Radii." Accessed from: <https://nacto.org/publication/urban-street-design-guide/intersection-design-elements/corner-radii/>.
- 32** Maclean, G., and Graham, C. (1996). *Bikes and Heavy Goods Vehicles*. CTC Occasional Paper No. 3. Cyclists Touring Club, Godalming, Surrey, UK; Enomoto, H., and Akiyama, K. (2005). *Development of Safety Concept Trucks; ASV Concept L and ASV Concept C*. Conference Proceedings,

19th International Technical Conference on the Enhanced Safety of Vehicles, Washington, D.C., June 6–9, 2005; Kim, J.-J., Kim, S., Ulfarsson, G., Porello, L. (2007). Bicyclist Injury Severities in Bicycle-Motor Vehicle Collisions. *Accident Analysis and Prevention*, Vol. 39, No. 2. p. 238–251; Moore, D. N., Schneider, W. H., Savolainen, P. T., and Farzaneh, M. (2011). Mixed Logit Analysis of Bicyclist Injury Severity Resulting from Motor Vehicle Crashes at Intersection and Non-Intersection Locations. *Accident Analysis and Prevention*, Vol. 43, No. 3, p. 621–630.

33 NACTO (2017c), “Bike Boxes.” *NACTO Urban Bikeway Design Guide*. National Association of City Transportation Officials, New York, NY. Accessed from: <http://nacto.org/publication/urban-bikeway-design-guide/intersection-treatments/bike-boxes/>. August 15, 2017.

34 FHWA (2017a). “MUTCD Interim Approval for Optional Use of Two-Stage Bicycle Turn Boxes (IA-20).” *Policy Memorandum*, Federal Highway Administration, US Department of Transportation, Washington, DC. Accessed from: https://mutcd.fhwa.dot.gov/resources/interim_approval/ia20/index.htm. August 15, 2017; FHWA (2016b). “MUTCD Interim Approval for Optional Use of an Intersection Bicycle Box (IA-18).” *Policy Memorandum*, Federal Highway Administration, US Department of Transportation, Washington, DC. Accessed from: https://mutcd.fhwa.dot.gov/resources/interim_approval/ia18/index.htm. August 15, 2017.

35 NACTO (2017c), “Colored Bike Facilities.” Accessed from: <http://nacto.org/publication/urban-bikeway-design-guide/bikeway-signing-marking/colored-bike-facilities/>.

36 NACTO (2017a), “Leading Pedestrian Interval.” Accessed from: <https://nacto.org/publication/urban-street-design-guide/intersection-design-elements/traffic-signals/leading-pedestrian-interval/>.

37 NACTO (2017c), “Colored Bike Facilities.” Accessed from: <https://nacto.org/publication/urban-bikeway-design-guide/bicycle-signals/bicycle-signal-heads/>.

38 FHWA (2013). “Interim Approval for Optional Use of a Bicycle Signal Face (IA-16).” *Policy Memorandum*, Federal Highway Administration, US Department of Transportation, Washington, DC. Accessed from: <https://mutcd.fhwa.dot.gov/>

resources/interim_approval/ia16/. August 15, 2017.

39 Knight, I. (2011). A Study of the Implementation of Directive 2007/38/EC on the Retrofitting of Blind Spot Mirrors to HGVs. Project Report PPR588. Transport Research Laboratory, Wokingham, Berkshire, UK. Accessed from: https://ec.europa.eu/transport/road_safety/sites/roadsafety/files/pdf/retrofitting_mirrors.pdf. August 15, 2017.

40 NYC DOT (2015). Urban Freight Initiatives. Department of Transportation, City of New York, NY. p. 19. Accessed from: <http://www.nyc.gov/html/dot/downloads/pdf/2015-09-14-urban-freight-initiatives.pdf>. August 15, 2017.

41 Dodd, M. (2009). Follow Up Study to the Heavy Goods Vehicle Blind Spot Modelling and Reconstruction Trial. Project Report PPR403. Transport Research Laboratory, Wokingham, Berkshire, UK. p. 15. Accessed from: <https://trl.co.uk/reports/PPR403>. August 15, 2017.

42 Center for Truck and Bus Safety, Virginia Tech Transportation Institute (2011). Field Demonstration of Heavy Vehicle Camera/Video Imaging Systems: Final Report. Prepared for the National Highway Traffic Safety Administration, US Department of Transportation, Washington, DC. Accessed from: <http://www.nhtsa.gov/DOT/NHTSA/NVS/Crash%20Avoidance/Technical%20Publications/2011/811475.pdf>. August 15, 2017.

43 TFL (2017b). “Direct Vision Standard for HGVs.” TFL Website, Transport for London, London, UK. Accessed from: <https://tfl.gov.uk/info-for/deliveries-in-london/delivering-safely/direct-vision-in-heavy-goods-vehicles>. August 15, 2017.

44 Volpe Center (2017a). “Truck Side Guards Resource Page.” Volpe Center Website, John A. Volpe National Transportation Systems Center, US Department of Transportation, Cambridge, MA. Accessed from: <https://www.volpe.dot.gov/our-work/truck-side-guards-resource-page>. August 15, 2017.

45 Volpe Center (2017b). Truck Side Guard Technical Overview. John A. Volpe National Transportation Systems Center, US Department of Transportation, Cambridge, MA. Accessed from: https://ntl.bts.gov/lib/54000/54900/54986/Truck_Side_Guard_Technical_Overview_2017-03-09.pdf. August 15, 2017.

46 Volpe Center (2017a).

47 NYC DOT (2015). p. 19.

48 FORS (2016). “Safe Urban Driving.” FORS Website, Fleet Operators Recognition Scheme, London, UK. Accessed from: <https://www.fors-online.org.uk/cms/safe-urban-driving/>. August 15, 2017.

49 FHWA (2017b). “Module 3 – Toolbox of Individual Traffic Calming Measures.” *Traffic Calmer ePrimer*, Federal Highway Administration, US Department of Transportation, Washington, DC. Accessed from: https://safety.fhwa.dot.gov/speedmgt/traffic_calmer.cfm

50 NACTO (2017a). “Speed Reduction Mechanisms.” Accessed from: <https://nacto.org/publication/urban-street-design-guide/design-controls/design-speed/speed-reduction-mechanisms/>. FHWA (2017b).

51 FHWA (2017b).

52 Snyder et al. (2013). p. 19.

53 *ibid*; FHWA (2017a). “Module 5 – Effects of Traffic Calming Measures on Non-Personal Passenger Vehicles.” Accessed from: https://safety.fhwa.dot.gov/speedmgt/traffic_calmer.cfm.

54 Van Zeebroeck, M., Lombaert, G., Dintwa, E., Ramon, H., Degrande, G., Tijskens, E. (2008). The simulation of the impact damage to fruit during the passage of a truck over a speed bump by means of the discrete element method. *Biosystems Engineering*, Vol. 101, No. 1. p. 58-68.

55 Marek, J. and Walgren, S. (1998).

56 FHWA (2017b).

57 NACTO (2017a), “Speed Cushion.” Accessed from: <https://nacto.org/publication/urban-street-design-guide/street-design-elements/vertical-speed-control-elements/speed-cushion/>; FHWA (2017b).

58 NACTO (2017a), “Mini Roundabout.” Accessed from: <https://nacto.org/publication/urban-street-design-guide/intersections/minor-intersections/mini-roundabout/>.

59 FHWA (2017b).

60 ITE (2010). p. 150.

- 61** ITE (2010). p. 134.
- 62** New York City Fire Code (2014). Chapter 5: Fire Operations Features, Section 503.2.6.
- 63** Snyder et al. (2013). p. 15.
- 64** ITE (2010), p. 134.
- 65** NYC DOT (2015). New York City Street Design Manual. Department of Transportation, City of New York, NY. p. 58. Accessed from: <http://www.nyc.gov/html/dot/downloads/pdf/nycdot-streetdesignmanual-interior-lores.pdf>. August 15, 2017.
- 66** NACTO (2017a), “Commercial Alley.” Accessed from: <https://nacto.org/publication/urban-street-design-guide/streets/commercial-alley/>.
- 67** TFL (2017a). p. 37.
- 68** FHWA (2009b). Urban Freight Case Studies: Washington, DC. Federal Highway Administration, US Department of Transportation, Washington, DC. Accessed from: <https://ops.fhwa.dot.gov/publications/fhwahop10018/>. August 15, 2017.
- 69** ITE (2010). p. 134.
- 70** NYC DOT (2015). p. 74.
- 71** Ripert, C. and Browne, M. (2009). La Démarche Exemple de Paris Pour le Transport de Marchandises en Ville. *Les Cahiers Scientifiques du Transport*, No. 55, p. 39-62.; City of Paris (2005). *Guide Technique des Aires de Livraison pour la Ville de Paris*. Direction de la Voirie & des Déplacements, Agence de la Mobilité, City of Paris.
- 72** TFL (2017). p. 38.
- 73** DOJ (2010). 2010 ADA Standards for Accessible Design. US Department of Justice, Washington, DC. Accessed from: <https://www.ada.gov/regs2010/2010ADASTandards/2010-ADASTandards.htm>. August 15, 2017.
- 74** City of Paris (2005). *Guide Technique des Aires de Livraison pour la Ville de Paris*. Direction de la Voirie & des Déplacements, Agence de la Mobilité, City of Paris.
- 75** Norwegian Public Roads Administration (2014). *Håndbok N100 -Veg- og gateutforming*. Statens vegvesen, Oslo, Norway. Accessed from: https://www.vegvesen.no/at-tachment/61414/binary/964095?fast_title=H%C3%A5ndbok+N100+Veg-+og+gateutforming+%288+MB%29.pdf. August 15, 2017.
- 76** Morris, A.G. (2009). Developing Efficient Freight Operations for Manhattan’s Buildings. The Stephen L. Newman Real Estate Institute, Baruch College, New York.
- 77** *ibid.*
- 78** Schaller, B., T. Maguire, D. Stein, W. Ng, M. Blakely (2011). Parking Pricing and Curbside Management in New York City. Compendium of Papers, TRB 90th Annual Meeting, Washington, DC, January 23-27, 2011.
- 79** USDOT (2017). Noteworthy Practices: Commercial Loading Zone Management Program, Washington, DC. Federal Highway Administration, US Department of Transportation. Accessed from: <https://ops.fhwa.dot.gov/publications/fhwahop17022/fhwahop17022.pdf>. August 7, 2017.
- 80** NYC DOT (2015). p. 12.
- 81** TFL (2017). p. 15.
- 82** AASHTO (2011). A Policy on Geometric Design of Highways and Streets. American Association of State Highway and Transportation Officials, Washington, DC. p. 2-4.
- 83** IAFC and FAMA (2011). *Emergency Vehicle Size and Weight Regulation Guideline*. International Association of Fire Chiefs, Fairfax, VA, and Fire Apparatus Manufacturers Association, Ocala, FL. Accessed from: https://fama.org/wp-content/uploads/2015/09/1441593313_55ecf7e17d32d.pdf. August 15, 2017.
- 84** New York City Fire Code (2014). Chapter 5: Fire Operations Features, Section 508.5.5.
- 85** NACTO (2017a), “Commercial Shared Street.” Accessed from: <https://nacto.org/publication/urban-street-design-guide/streets/commercial-shared-street/>.
- 86** *ibid.*

4 Demand Management Strategies

Both freight and emergency vehicle activities occur to meet the demands generated by a community. Freight deliveries, particularly in urban areas, are often inefficient due to a number of factors. Deliveries usually occur at a time requested by the receiver, which is often during peak daytime hours when operators must contend with crowded streets and sidewalks, traffic congestion, and competition for limited road and curb space. When drivers face long and unreliable travel times, the number of trips they can make during a delivery tour is reduced, increasing the number of vehicles and drivers and the total VMT required to complete a fixed number of deliveries. As both businesses and residents continue to request increasingly specific on-demand deliveries, last-mile trips are becoming more distributed in both time and space, and shipment sizes are shrinking. A large and quickly growing number of trips are now destined to residential addresses; compared to commercial trips, these deliveries fail more frequently—often a package cannot be left if the recipient is not at home or if there is no safe place to leave it. These failures are problematic for receivers, shippers, carriers, and the surrounding community. Receivers are unsatisfied when their goods are not delivered on-time. Shippers are at risk of losing customers when goods do not reach their receivers. For carriers, failures result in wasted time and fuel and expensive repeated trips. These trips increase the number of truck trips, and related VMT, required to complete deliver-

ies, resulting in increased congestion impacts and space consumption, higher emissions, and increased exposure risk for interactions with trucks. Emergency operators must also respond whenever emergency services are requested, and must do so at high speeds when patients or potential victims are at risk.

A number of strategies can be implemented in a community to reduce demand for freight and emergency vehicle trips; however, these are not simple to execute. For successful implementation, demand management strategies require interest and participation from multiple stakeholders, and often require direct investments in space, infrastructure, equipment, or staff by businesses, governments, or building owners. Supporting legislative action may also be needed. The following sections provide a basic description of potential demand management strategies, their benefits, and the challenges to their implementation. For more detail on these solutions, see the additional references listed in Chapter 5.

4.1 Off-Hour Deliveries

The detrimental traffic, environmental, and safety impacts of freight activity can be reduced if deliveries occur during off-peak hours when streets are less congested, when there is less competition for limited curb space, and when fewer vehicles and non-motorized travelers

are present. A pilot study in NYC identified a number of specific benefits from off-hour deliveries for individual stakeholders.¹ For carriers, these include increased travel speeds, reduced congestion delays, reduced delivery times, fewer parking tickets, and in some cases, better fleet utilization when the same vehicles could be used for both off-hour and peak hour delivery tours. For receivers, deliveries could occur without interference to customer service, without occupation of parking space that could otherwise be used by customers, and with more arrival time reliability.² For the surrounding community, fewer congestion impacts, fewer interactions between trucks and non-motorized travelers, and reduced emissions could be achieved.³

However, a number of challenges need to be overcome to successfully shift delivery operations to off-peak hours.⁴ First, delivery times are not typically determined by a carrier alone, but rather jointly between a carrier and receiver;⁵ for most businesses (receivers), deliveries are scheduled during hours when staff are at work. For attended deliveries during off-peak hours, businesses may need to pay a staff member for additional hours. If the cost to do so outweighs any transportation cost savings to the receiver for off-peak vs. peak hour operations, businesses are unlikely to switch. While cost savings from off-hour operations for a carrier may be substantial, these savings are not necessarily passed on to the receivers. Second, delivery

activities—including vehicle operations, deployment of lift gates and ramps, loading/unloading, and opening and closing doors—can generate a significant amount of noise. This noise is especially problematic where residents live above, adjacent to, or nearby businesses. Third, drivers themselves should be safe; those operating at night, particularly in low activity areas that are not well lit, can be targeted for robbery during delivery operations.

New technologies, equipment, and training have potential to address some of these challenges; for example, remote access alternatives—including key/keypad access, double doors, delivery lockers, and container/storage pods,⁶ sometimes coupled with surveillance or “electronic door-man” systems⁷ can be implemented to enable secure unassisted deliveries. Low noise vehicle and handling equipment can also reduce noise impacts, especially if operators are well trained.⁸ Public sector interventions could also play a role in mitigating receiver costs; for example, tax incentives could be employed to encourage businesses to accept off-hour deliveries.⁹

4.2 Urban Consolidation Centers

According to the *BESTUFS Good Practice Guide on Urban Freight Transport*, an urban consolidation center (UCC) is “a logistics facility that is situated relatively close to the area that it serves



(be that a city center, an entire town or a specific site) from which consolidated deliveries are carried out within that area.”¹⁰ Typically, goods are delivered to a UCC via a large truck or van, sorted, and transloaded to smaller, greener vehicles for end delivery. UCCs typically serve a relatively small radius, usually in a densely developed area where end receivers are located in

close proximity and where larger vehicles would be likely to face challenges from congestion and limited space. UCCs can be operated privately, by a public authority, or through a public-private partnership; for a detailed discussion of UCC organizational models, readers are referred to Panero, Shin, and Lopez’s *Urban Distribution Centers: A Means to Reducing Freight Vehicle*

Miles Traveled, which provides a detailed discussion of models deployed internationally.¹¹

The primary social benefits of UCCs are to reduce the number of heavy vehicle trips (and related VMTs) in a service area; to improve vehicle load factors in a service area by combining deliveries for multiple customers in a single last-mile trip;¹² and to enable lower impact vehicles such as electric trucks/vans or cargo cycles to be used for last-mile deliveries. The primary benefit for shippers/carriers is to enable them to avoid expensive last-mile delivery trips and their related costs such as delay time, wasted fuel, and parking fines. For receivers, UCCs can improve local delivery reliability, and some also provide added value services such as local stock-holding or pre-retailing (e.g., package removal, quality control) for businesses and collection of waste or recycling from backhaul operations.¹³

However, international UCC implementations have produced very mixed results, with UCCs frequently failing. For successful implementation, UCCs must provide value to all involved stakeholders—including shippers, carriers, receivers, public authorities, and possibly a private facility operator.¹⁴ Public subsidy is frequently required to initiate a UCC due to high start-up costs and time required to reach adequate flows.¹⁵ Once operational, UCCs generally must charge participants a service fee in order to cover operating costs for transloading (e.g., land, buildings, and staff) and for last-mile delivery. In dense urban

areas where UCCs are most beneficial, space can be extremely expensive.¹⁶ When goods are moved to smaller capacity vehicles, more vehicles and more drivers are required to move the same number of goods.¹⁷ If the cost to use a UCC is higher than savings for delivery costs without use of the UCC (e.g., fuel, staff time, parking tickets), shippers and/or carriers will usually not choose to use a UCC.¹⁸ Shippers may also be hesitant to send their goods through a UCC if they are concerned about a third-party representing their business during delivery to a final customer.¹⁹

While the high cost of operations results in many UCC failures, studies have identified a several factors indicative of successful UCC implementation. UCCs initiated by private entities looking to improve their operations, or that at least have early support from private businesses, are more likely to succeed than those initiated by public authorities alone.²⁰ UCCs are also more likely to be successful in areas where large vehicle operations are most difficult, e.g., where restrictions prohibit large vehicle operations at some or all times of the day²¹ or where congestion is severe or space is extremely constrained.²² Public interventions can also reduce the cost difference between UCC and non-UCC operations. For example, in the City of Paris, France, government-subsidized “urban logistics spaces” are provided to some UCC operators at a below-market rent cost.²³

4.3 Lockers and Pick-up Points

Deliveries to residential homes present a unique challenge to operators. Goods destined to addresses where no one is home to accept a package and where there is nowhere safe to leave an unattended package can result in a failed delivery—meaning the package cannot be left and is likely returned to a distribution facility. A recent UK study noted that failures are most frequent for deliveries by parcel carriers compared to other types of home deliveries,²⁴ and another study in France and Germany confirmed that failed deliveries are a major concern for parcel operators.²⁵ Recognizing the great expense associated with these failed deliveries, major shippers and carriers have begun to implement new distribution methods to reduce the rate of failed deliveries. Two common strategies are the implementation of staffed pickup points and installation of unmanned delivery lockers.²⁶ UPS now has “Access Points” in local businesses such as pharmacies; receivers can request that their goods be delivered to these points for pickup from staff.²⁷ While Amazon has not yet implemented pickup points in the US, the company has implemented a network in Australia by partnering with a third-party operator.²⁸ In the U.S., Amazon, UPS, and FedEx have all implemented networks of pick-up lockers, located either in public spaces or in neighborhood businesses such as grocery stores or pharmacies, to which goods can be delivered instead of directly

to a home. Amazon is also piloting multi-carrier delivery lockers at residential buildings.²⁹ Receivers access these secure lockers using a keycode sent to them by the operator. The 2016 UPS Pulse of the Online Shopper report notes that 15% of online shoppers now prefer delivery to a carrier-owned pickup location (e.g., a UPS Store), a third-party location (e.g., grocery or convenience store) or a package delivery locker.³⁰ Both UPS³¹ and FedEx³² also now offer services that allow receivers to redirect goods in transit to these or to alternate delivery locations.

Use of locker and pickup point solutions can help carriers to increase the number of successful first-time deliveries and to better optimize their delivery tours, ultimately reducing their operating costs and the traffic, environmental, and safety impacts of their trips.³³ The primary challenges to implementation are security concerns and identifying partner businesses willing to host these solutions, particularly in areas where space is very valuable. McKinnon and Tallam note that the primary security risk in the implementation of communal delivery lockers is not theft of the goods from the locker, which are secured through the use of keycode technologies, but rather robbery of the user during pickup.³⁴ This risk can be mitigated by locating the lockers in well-lit areas and through deployment of security technologies such as CCTV cameras. UPS advertises two primary benefits for trusted business partners to serve as access points: generating foot-traffic to a store location



and enabling them to provide an added value service for customers.³⁵

4.4 Secondary Referrals

While rapid response must be provided for patients experiencing serious medical conditions, not all patients requesting emergency medical services meet this level of critical need. Integration of secondary referral services into 911 operations can help to divert non-critical patients to nearby medical facilities, eliminating unnecessary ambulance trips. An Australian study examined the benefits of a referral service implemented in the state of Victoria—which includes Melbourne and surrounding suburban and rural areas. The referral service diverts calls from “low priority” patients to a nurse or paramedic, who evaluates their situation and determines if ambulance service are needed.³⁶ The study found that of about 10% of calls diverted to this service, about one third could be referred to alternative service providers; of the remaining calls referred to an emergency department, only 40 percent required emergency ambulance services, with the other trips completed by non-emergency ambulance or private car.³⁷ A study of similar services in Forth Worth, Texas and Louisville, Kentucky that examined 3,976 cases found that 493 ambulance trips were avoided.³⁸

While the benefits of secondary referral services are measurable, to ensure effectiveness without a loss in quality of care, they also require significant investment in staff and technology support. Fivaz and Marshall identify several critical factors for successful implementation of services: in addition to achieving high-level protocols requiring significant staff training, a high-quality clinical decision software system, trained medical professionals to respond to individual patient cases, and a comprehensive directory of available services are also required.³⁹

4.5 Building Fireproofing

Fires require rapid response to prevent them from reaching the point of flashover, spreading to adjacent buildings, and structural collapse. Sprinklers can reduce the intensity of a fire, increasing the time it will take for a fire to flash-over or spread.⁴⁰ Spray-applied mineral-fiber mixtures and cementitious coatings, intumescent coatings, and concrete and masonry encasements can all be used to protect structural steel and increase time to failure.⁴¹ In order to be effective, however, both sprinklers and other methods of fireproofing must be well designed and maintained.



Endnotes

- 1** NYC DOT (2010). *2010 Sustainable Streets Index*. Department of Transportation, New York City. P. 62-65. Accessed from: http://www.nyc.gov/html/dot/downloads/pdf/sustainable_streets_index_10.pdf. August 15, 2017.
- 2** NYC DOT (n.d.). "Off-Hour Deliveries Overview." NYCDOT Website. New York City Department of Transportation, New York, NY. Accessed from: <http://www.nyc.gov/html/dot/downloads/pdf/off-hours-delivery-overview.pdf>. August 15, 2017.
- 3** *ibid*
- 4** Holguín-Veras, J., Marquis, R., Campbell, S., Wojtowicz, J., Wang, C., Jaller, M., Hodge, S.D., Rothbard, S., and Goevaers, R. (2013). Fostering the Use of Unassisted Off-Hour Deliveries: Operational and Low-Noise Truck Technologies. *Transportation Research Record: Journal of the Transportation Research Board*, No. 2379, p. 57–63.
- 5** Holguín-Veras, J. (2008). Necessary conditions for off-hour deliveries and the effectiveness of urban freight road pricing and alternative financial policies in competitive markets. *Transportation Research Part A*, Vol. 42. pp. 392–413.
- 6** NYC DOT Off-Hour Deliveries Overview
- 7** Holguín-Veras et al. (2013)
- 8** *ibid*
- 9** Holguín-Veras, J., and Polimeni, J. (2006). *Potential for Off-Peak Freight Deliveries to Congested Urban Areas*. Final Report, TIRC Project C-02-15, New York State Department of Transportation. Accessed from: http://homepages.rpi.edu/~holguj2/OPD/OPD_FINAL_REPORT_12-18-06.pdf. August 15, 2017.
- 10** Allen, J., Thorne, G., and Browne, M. (2007). *BESTUFS Good Practice Guide on Urban Freight Transport*. Rijswijk, The Netherlands: BESTUFS Consortium. p. 59-78.
- 11** Panero, M., Shin, H., and Lopez, D. (2011). Urban Distribution Centers: A Means to Reducing Freight Vehicle Miles Traveled. Final Report C-08-23, Prepared for the New York State Energy Research and Development Authority and the New York State Department of Transportation. Accessed from: https://www.dot.ny.gov/divisions/engineering/technical-services/trans-r-and-d-repository/C-08-23_0.pdf. August 15, 2017.
- 12** van Rooijena, T. and Quak, H. (2010). Local impacts of a new urban consolidation centre – the case of Binnenstadservice.nl. *Procedia Social and Behavioral Sciences*, Vol. 2. p. 5967–5979
- 13** Allen, Thorne, and Browne (2007)
- 14** van Duin, J.H.R., van Dam, T., Wiegman, B., and Tavasszy, L. (2016). Understanding Financial Viability of Urban Consolidation Centres: Regent Street (London), Bristol/Bath & Nijmegen. *Transportation Research Procedia*, Vol. 16, p. 61 – 80.
- 15** Allen, J., Browne, M., Woodburn, A., and Leonardi, J. (2012). The Role of Urban Consolidation Centres in Sustainable Freight Transport. *Transport Reviews*, Vol. 32 , No. 4. p. 473-490.
- 16** Allen, Thorne, and Browne (2007)
- 17** van Rooijena, T. and Quak, H. (2010)
- 18** Kin, B., Verlinde, S., van Lier, T., and Macharis, C. (2016). Is there life after subsidy for an urban consolidation centre? An investigation of the total costs and benefits of a privately initiated concept. *Transportation Research Procedia*, Vol. 12. p. 357 – 369.
- 19** Allen, Thorne, and Browne (2007)
- 20** *ibid*
- 21** van Rooijena, T. and Quak, H. (2010)
- 22** Allen, Thorne, and Browne (2007)
- 23** Dablanc, L. (2011). *Transferability of Urban Logistics Concepts and Practices from a Worldwide Perspective - Deliverable 3.1 - Urban Logistics Practices – Paris Case Study*. Prepared for the European Commission. TURBLOG Consortium, Lisbon, Portugal.
- 24** Allen, J., Piecyk, M., and Piotrowska, M. *An Analysis of Online Shopping and Home Delivery in the UK*. University of Westminster, London, UK, 2017. Accessed from: http://www.ftc2050.com/reports/Online_shopping_and_home_delivery_in_the_UK_final_version_Feb_2017.pdf. August 15, 2017.
- 25** Morganti, E., Seidel, S., Blanquart, C., Dablanc, L., and Lenz, B. (2014). The impact of e-commerce on final deliveries: alternative parcel delivery services in France and Germany. *Transportation Research Procedia* Vol. 4, p. 178 – 190.
- 26** Visser, J., Nemoto, T., and Browne, M. (2014). Home Delivery and the Impacts on Urban Freight Transport: A Review. *Procedia - Social and Behavioral Sciences*, Vol. 125, p. 15 – 27; Lamm, C., Kirk, K., Stewart, B., Fregonese, J., and Joyce, A. (2017). *Guide for Integrating Goods and Service Movement by Commercial Vehicles in Smart Growth Environments*. NCHRP Report 844, Transportation Research Board of the National Academies of Sciences, Engineering, and Medicine, Washington, DC.
- 27** UPS (2017a). "UPS Access Point™ Deliveries." UPS Website, United Parcel Service, Atlanta, GA. Accessed from: <https://www.ups.com/us/en/services/individual-shipper/ups-access-point-deliveries.page>. August 15, 2017.
- 28** Turner, A. (2015). "Amazon adds more than 1000 Australian pickup locations with ParcelPoint." *The Sydney Morning Herald*, December 9, 2015. Accessed from: <http://www.smh.com.au/digital-life/computers/gadgets-on-the-go/amazon-adds-more-than-1000-australian-pickup-locations-with-parcelpoint-20151209-glj1om.html>, August 15, 2017.
- 29** Amazon (2017). "hub: Welcome home, deliveries." Amazon Website, Amazon.com, Inc., Seattle, WA. Accessed from: <https://thehub.amazon.com/>. August 15, 2017.
- 30** UPS (2016). Pulse of the Online Shopper Study. United Parcel Service, Atlanta, GA.
- 31** UPS (2017b). "UPS MyChoice®." UPS Website, United Parcel Service, Atlanta, GA. Accessed from: https://www.wapps.ups.com/mcdp?loc=en_US. August 15, 2017.
- 32** FedEx(2017). "FedEx Delivery Manager." FedEx Website, FedEx, Memphis, TN. Accessed from: <https://www.fedex.com/us/delivery/>. August 15, 2017.
- 33** Morganti et al. (2014).
- 34** McKinnon, A., and Tallam, D. (2003). Unattended deliv-

ery to the home: an assessment of the security Implications. *International Journal of Retail & Distribution Management*, Vol. 31, No. 1, p.30-41.

35 UPS (2017c). “UPS Access Point™ Network.” UPS Website, United Parcel Service, Atlanta, GA. Accessed from: <https://www.ups.com/us/en/services/e-commerce/access-point-network/recruit.page>. August 15, 2017.

36 CIPHER (2012). “Secondary service cuts emergency ambulance demand.” Research Update, Centre for Informing Policy in Health with Evidence from Research, Ultimo, New South Wales, Australia. Accessed from: <https://cipher.org.au/secondary-service-cuts-emergency-ambulance-demand/> August 15, 2017.

37 Eastwood, K. Morgans, A., Smith, K., Hodgkinson, A. Becker, G., and Stoelwinder, J. (2015). A novel approach for managing the growing demand for ambulance services by low-acuity patients. *Australian Health Review*, Vol. 40, No. 4. p. 378-384.

38 Gardett, I. Scott, G., Clawson, J., Miller, K., Richmond, N., Sasson, C., Zavadsky, M., Rector, M., Wilcox, A., and Olola, C. (2015). 911 Emergency Communication Nurse Triage Reduces EMS Patient Costs and Directs Patients to High-Satisfaction Alternative Point of Care. *Annals of Emergency Dispatch & Response*, Vol. 3, No. 1. p. 8-13.

39 Fivaz, C. and Marshall, G. (2015). *Necessary Components of a Secondary Telephonic Medical Triage System at 9-1-1*. White Paper, International Academies of Emergency Dispatch, Salt Lake City, UT. Accessed from: http://www.emergencydispatch.org/sites/default/files/Science%20Tab/Position%20Papers_Standards%20Documents/WhitePaper-SecondaryMedicalTriageComponentsFINAL8272015.pdf. August 15, 2017.

40 Snyder, R., Siegman, P., Huff, H., and McCormick, C. (2013). *Best Practices: Emergency Access in Healthy Streets*. Los Angeles County Department of Public Health, Los Angeles, CA. Accessed from: <https://www.cnu.org/sites/default/files/Best-Practices-Emergency-Access-in-Healthy-Streets.pdf>. August 15, 2017.

41 Alfakhiri, F., Hewiit, C., and Solomon, R. (2012). “Structural Fire Protection: Common Questions Answered.”

Modern Steel Construction, December 2002. American Institute of Steel Construction, Chicago, IL. Accessed from: https://www.aisc.org/globalassets/modern-steel/archives/2002/12/2002v12_fire.pdf. August 15, 2017.

5 Recommended Resources

Freight

Fundamentals of Freight

- ◆ Wilbur Smith Associates and S.R. Kale Consulting (2010). *A Guidebook for Engaging the Private Sector in Freight Transportation Planning*. Prepared for the Federal Highway Administration, US Department of Transportation, Washington, DC.
- ◆ Rhodes, S., Berndt, M., Bingham, P., Bryan, J., Cherrett, T., Plumeau, P., Weisbrod, R. (2012). *Guidebook for Understanding Urban Goods Movement*. NCFRP Report 14, Transportation Research Board of the National Academies of Sciences, Engineering, and Medicine, Washington, DC.
- ◆ Holguín Veras, J., Jaller, M., Sánchez-Díaz, I., Wojtowicz, J., Campbell, S., Levinson, H., Lawson, C., Powers, E., and Tavasszy, L. (2012). *Freight Trip Generation and Land Use*. NCHRP Report 739/NCFRP Report 19, Transportation Research Board of the National Academies of Sciences, Engineering, and Medicine, Washington, DC.
- ◆ FHWA (2015). *Compilation of Existing State Truck Size and Weight Limit Laws*. Report to Congress, May 2015. Federal Highway Administration, US Department of Transportation, Washington, DC. Accessed from: https://ops.fhwa.dot.gov/FREIGHT/policy/rpt_congress/truck_sw_laws/truck_sw_laws.pdf. August 15, 2017.

Design Guidance

- ◆ Portland Office of Transportation (2008). *Designing for Truck Movements and Other Large Vehicles in Portland*. Office of Transportation, City of Portland, Portland, OR.
- ◆ Renaissance Planning (2015). *Freight Roadway Design Considerations*. Prepared for the Florida Department of Transportation District 7 Office of Intermodal Systems Development, Tampa, FL.
- ◆ FHWA (2016). *Achieving Multimodal Networks: Applying Design Flexibility and Reducing Conflicts*. Federal Highway Administration, US Department of Transportation, Washington, DC.
- ◆ TFL (2017). *Kerbside Loading Guidance*, 2nd Edition. Transport for London, London, UK. p. 38. Accessed from: <http://content.tfl.gov.uk/kerbside-loading-guidance.pdf>. August 15, 2017.

Demand and Externality Management

- ◆ Allen, J., Thorne, G., and Browne, M. (2007). *BESTUFS Good Practice Guide on Urban Freight Transport*. BESTUFS Consortium. Accessed from: http://www.bestufs.net/download/BESTUFS_II/good_practice/English_BESTUFS_Guide.pdf. August 15, 2017.
- ◆ Giuliano, G. and Dablanc, L. (2013). *Approaches to Managing Freight in Metropolitan Areas*. In *City Logistics Research: A Transatlantic Perspective*. Transportation Research Board of the National Academies of Sciences, Engineering, and Medicine, Washington, DC.
- ◆ Holguin-Veras, J., Amaya-Leal, J., Wojtowicz, J., Jaller, M., Gonzalez-Calderon, C., Sanchez-Diaz, I., Wang, X., Haake, D., Rhodes, S., Hodge, S., Frazier, R., Nick, M., Dack, J., Casinelli, L., Browne, M. (2015). *Improving Freight System Performance in Metropolitan Areas: A Planning Guide*. NCFRP Report 33, Transportation Research Board of the National Academies of Sciences, Engineering, and Medicine, Washington, DC.
- ◆ Lamm, C., Kirk, K., Stewart, B., Fregonese, J., and Joyce, A. (2017). *Guide for Integrating Goods and Service Movement by Commercial Vehicles in Smart Growth Environments*. NCHRP Report 844, Transportation Research Board of the National Academies of Sciences, Engineering, and Medicine, Washington, DC.

Emergency Services

Fundamentals of Emergency Services

- ◆ Snyder, R., Siegman, P., Huff, H., and McCormick, C. (2013). *Best Practices: Emergency Access in Healthy Streets*. Los Angeles County Department of Public Health, Los Angeles, CA. Accessed from: <https://www.cnu.org/sites/default/files/Best-Practices-Emergency-Access-in-Healthy-Streets.pdf>. August 15, 2017.
- ◆ IAFC and FAMA (2011). *Emergency Vehicle Size and Weight Regulation Guideline*. International Association of Fire Chiefs, Fairfax, VA, and Fire Apparatus Manufacturers Association, Ocala, FL. Accessed from: https://fama.org/wp-content/uploads/2015/09/1441593313_55ecf7e17d32d.pdf. August 15, 2017.

Design Guidance

- ◆ ITE (2017). *Implementing Context Sensitive Design on Multimodal Corridors: A Practitioner's Handbook*. Institute of Transportation Engineers, Washington, DC.
- ◆ FHWA (2017a). "Module 5 – Effects of Traffic Calming Measures on Non-Personal Passenger Vehicles." *Traffic Calming ePrimer*. Federal Highway Administration, US Department of Transportation, Washington, DC. Accessed from: https://safety.fhwa.dot.gov/speedmgt/ePrimer_modules/module5.cfm. August 15, 2017.

Credits

Content Development, Writing, and Text Editing:

Alison Conway

Stacey Hodge

Diniece Peters

Nicola Mammes

Michael Klatsky

Quanquan Chen

Linette Prasad

Layout Design, Visualization Development and Photo Editing:

June Williamson

Marija Gjorgjievska

Crystal Xing

Photography:

Alison Conway

Quanquan Chen

Lisa Douglass

Project Management:

Robyn Marquis



The City College
of New York

**CU
NY** The City
University
of
New York

